



---

## **MedLED** Chrome

Truly Cordless™ Headlight Technology



Denken, fühlen, modulare Beleuchtung...  
unermüdliches Licht für das Leben!

Think, feel, modular illumination...  
relentless light for life!

## MedLED Chrome Stirnleuchten Headlights

### Freiheit ohne Kompromisse

Die MedLED-Chrome-Stirnleuchte verfügt über die modernste Lichttechnologie, und erreicht so, was früher unmöglich war: eine Stirnleuchte, die jedes beliebige OP-Feld ausleuchten kann, sowohl in Bezug auf Lichtintensität als auch Spotgröße, und dabei lautlos, komfortabel und kabellos ist.

### Merkmale

- Lichtintensität:  
MC3 – 100.000 lux  
MC6 – 200.000 lux  
MC7 – 250.000 lux
- Akkulaufzeit:  
MC3 – 7,75 Std.  
MC6 – 6,75 Std.  
MC7 – 3,50 Std.
- Akkulaufzeit: siehe oben, abhängig vom Modell; praktisch unbeschränkt dank Ladegerät mit 4 Ladeschächten
- USB-Ladedauer: 6,5 Stunden
- Ladedauer im 4-Schacht-Ladegerät: 10 Stunden; gleichzeitiges Aufladen von bis zu zwei Sets
- Justierung: volle Einstellbarkeit des Strahlwinkels, Links-Rechts-schwenkbar, größerer Spotgrößenbereich
- Spot-Qualität: scharf abgegrenzter, kreisförmiger Strahl mit homogenem Licht

### Freedom without sacrifice

The MedLED Chrome headlight has incorporated the best that technology offers to accomplish the once impossible; a headlight that can light up any field in the O.R. in terms of both intensity and spot size and is silent, comfortable, and cordless.

### Features

- Luminous intensity:  
MC3 – 100,000 lux  
MC6 – 200,000 lux  
MC7 – 250,000 lux
- Battery service life:  
MC3 – 7.75 hr  
MC6 – 6.75 hr  
MC7 – 3.50 hr
- Battery service life: see above, depends on model; infinite with 4-bay charger
- USB charging time: 6.5 hours
- 4-Bay charging time: 10 hours; charge up to two sets at a time
- Adjustability: full beam angle adjustability, left-to-right swivel, increased spot size range
- Spot quality: crisp, circular beam of homogenous light

## MedLED Chrome

### Freiheit ohne Kompromisse

Wenn Sie eine leistungsfähige, langlebige, komfortable Stirnleuchte ohne Kabel suchen, kann Ihnen KLS Martin ein vollständiges Sortiment an Stirnleuchten mit passendem Zubehör anbieten.

### Freedom without sacrifice

If you have a need for a powerful, long lasting, comfortable headlight with no cord, KLS Martin is able to offer you a full range of headlights and accessories.



## Intensität und Helligkeit Power and Brightness

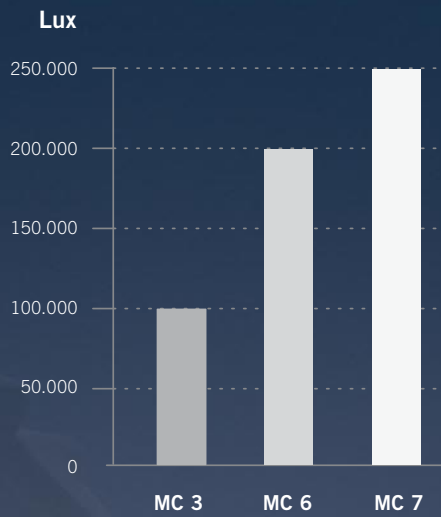

**maximum spot diameter range**  
Maßstab/scale 1:1

200 mm  
**MC 7**

100 mm  
**MC 3**

90 mm  
**MC 6**

## MedLED Chrome

### Integrierte Schaltkreise

Dies ist unsere Leitlinie.  
Keine Gürteltasche, keine Kabel, keine Probleme,  
sondern wirklich kabelloser Betrieb.  
Licht ohne Kompromisse!

Keine Beeinträchtigung der Sterilität.  
Ohne Kabel oder Akkupack am Gürtel.

### Head-mounted circuit technology

That's our mission statement.  
No cables, no hassles. Lose the optical cables  
and belt pack cords and go cordless without  
sacrificing basic operating light needs.

Does not interfere with sterility.  
Without cables or battery belt packs,  
it's kept safely above the neck.

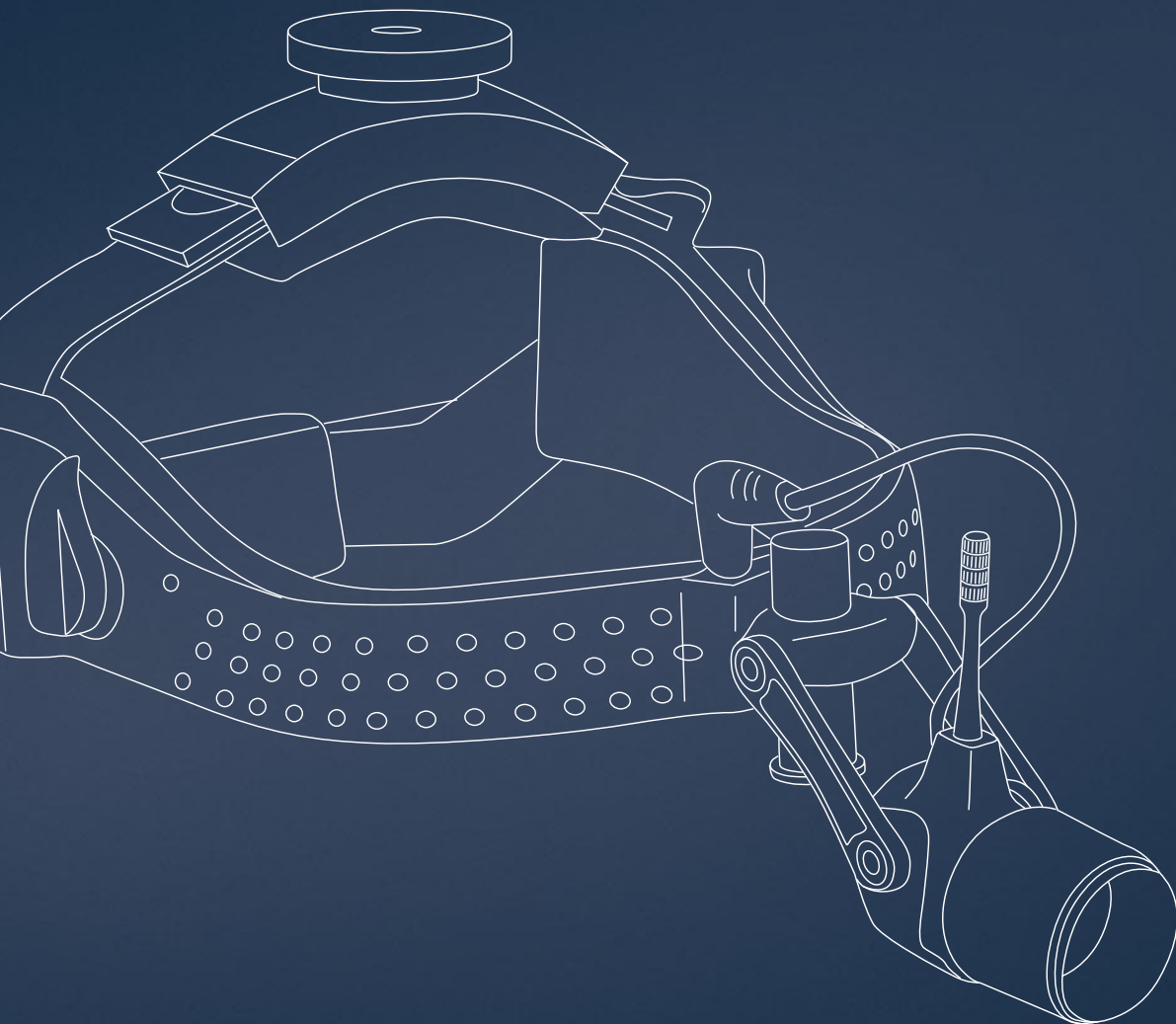

### Quiet-Cool™ Kühlkörper-Technologie

Kühl und leise

Um unnötiges Erwärmen zu vermeiden, wird die LED mithilfe einer firmeneigenen Technologie sofort gekühlt. Wir haben außerdem das Gehäuse so gestaltet, dass es mögliche Restwärme selbst ableitet.

Lüfter brauchen mehr Strom und dadurch große Akkus, die an der Taille des Benutzers befestigt werden müssen. Hiermit gehören die Lüfter der Vergangenheit an.

### Quiet-Cool™ Heatsink technology

Cool and quiet

Proprietary technology is used to cool the LED instantly, avoiding the potential for unnecessary heat buildup. We also designed the housing itself to manage any remaining thermal dissipation.

Fans also demand more power, requiring large batteries attached to the waist of the user.

### Einstellbarkeit und Steuerung des Spots Spot Adjustability and Control

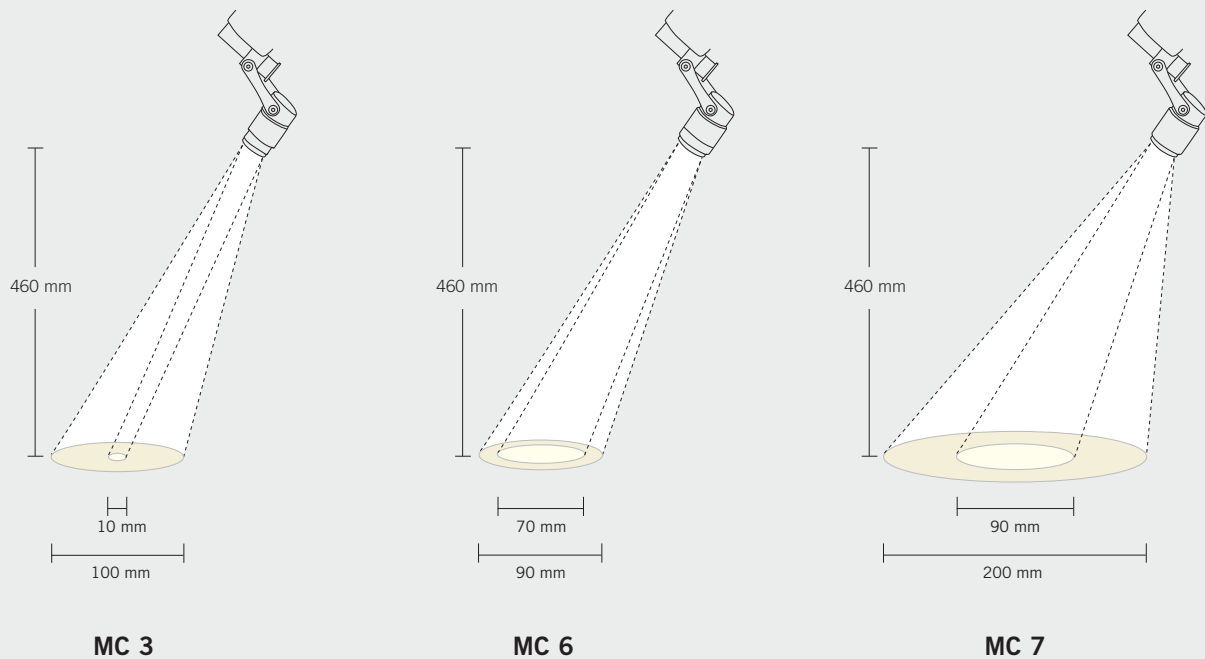



## MedLED Chrome

### Stirnleuchten/Headlights

Ready to use!

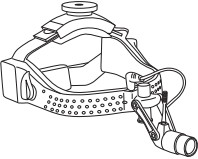
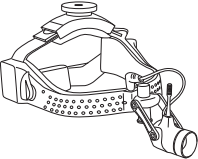
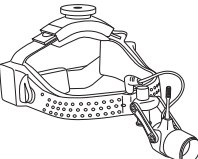
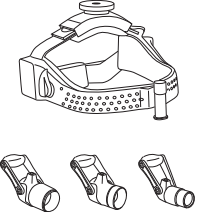
	<table border="1"> <thead> <tr> <th data-bbox="336 568 1238 607">MedLED Chrome MC 3</th> <th data-bbox="1238 568 1396 607">Item No.</th> </tr> </thead> <tbody> <tr> <td data-bbox="336 607 1238 712">                     bestehend aus:                      Stirnleuchte MedLED Chrome MC 3 (Hardtop), Transportkoffer, USB-Ladekabel, Netzteil inkl. Adapter EU, US, UK, AU und 2 Akkus (Lithium-Polymer)                 </td> <td data-bbox="1238 607 1396 712"></td> </tr> <tr> <td data-bbox="336 712 1238 837">                     consisting of:                      headlight MedLED Chrome MC 3 (hardtop), carrying case, USB charging cable, PSU incl. adapter for EU, US, UK, AU and 2 rechargeable lithium-polymer batteries                 </td> <td data-bbox="1238 712 1396 837">17-500-40-04</td> </tr> </tbody> </table>	MedLED Chrome MC 3	Item No.	bestehend aus: Stirnleuchte MedLED Chrome MC 3 (Hardtop), Transportkoffer, USB-Ladekabel, Netzteil inkl. Adapter EU, US, UK, AU und 2 Akkus (Lithium-Polymer)		consisting of: headlight MedLED Chrome MC 3 (hardtop), carrying case, USB charging cable, PSU incl. adapter for EU, US, UK, AU and 2 rechargeable lithium-polymer batteries	17-500-40-04
MedLED Chrome MC 3	Item No.						
bestehend aus: Stirnleuchte MedLED Chrome MC 3 (Hardtop), Transportkoffer, USB-Ladekabel, Netzteil inkl. Adapter EU, US, UK, AU und 2 Akkus (Lithium-Polymer)							
consisting of: headlight MedLED Chrome MC 3 (hardtop), carrying case, USB charging cable, PSU incl. adapter for EU, US, UK, AU and 2 rechargeable lithium-polymer batteries	17-500-40-04						
	<table border="1"> <thead> <tr> <th data-bbox="336 913 1238 952">MedLED Chrome MC 6</th> <th data-bbox="1238 913 1396 952">Item No.</th> </tr> </thead> <tbody> <tr> <td data-bbox="336 952 1238 1057">                     bestehend aus:                      Stirnleuchte MedLED Chrome MC 6 (Hardtop), Transportkoffer, USB-Ladekabel, Netzteil inkl. Adapter EU, US, UK, AU und 2 Akkus (Lithium-Polymer)                 </td> <td data-bbox="1238 952 1396 1057"></td> </tr> <tr> <td data-bbox="336 1057 1238 1182">                     consisting of:                      headlight MedLED Chrome MC 6 (hardtop), carrying case, USB charging cable, PSU incl. adapter for EU, US, UK, AU and 2 rechargeable lithium-polymer batteries                 </td> <td data-bbox="1238 1057 1396 1182">17-500-50-04</td> </tr> </tbody> </table>	MedLED Chrome MC 6	Item No.	bestehend aus: Stirnleuchte MedLED Chrome MC 6 (Hardtop), Transportkoffer, USB-Ladekabel, Netzteil inkl. Adapter EU, US, UK, AU und 2 Akkus (Lithium-Polymer)		consisting of: headlight MedLED Chrome MC 6 (hardtop), carrying case, USB charging cable, PSU incl. adapter for EU, US, UK, AU and 2 rechargeable lithium-polymer batteries	17-500-50-04
MedLED Chrome MC 6	Item No.						
bestehend aus: Stirnleuchte MedLED Chrome MC 6 (Hardtop), Transportkoffer, USB-Ladekabel, Netzteil inkl. Adapter EU, US, UK, AU und 2 Akkus (Lithium-Polymer)							
consisting of: headlight MedLED Chrome MC 6 (hardtop), carrying case, USB charging cable, PSU incl. adapter for EU, US, UK, AU and 2 rechargeable lithium-polymer batteries	17-500-50-04						
	<table border="1"> <thead> <tr> <th data-bbox="336 1258 1238 1296">MedLED Chrome MC 7</th> <th data-bbox="1238 1258 1396 1296">Item No.</th> </tr> </thead> <tbody> <tr> <td data-bbox="336 1296 1238 1402">                     bestehend aus:                      Stirnleuchte MedLED Chrome MC 7 (Hardtop), Transportkoffer, USB-Ladekabel, Netzteil inkl. Adapter EU, US, UK, AU und 2 Akkus (Lithium-Polymer)                 </td> <td data-bbox="1238 1296 1396 1402"></td> </tr> <tr> <td data-bbox="336 1402 1238 1527">                     consisting of:                      headlight MedLED Chrome MC 7 (hardtop), carrying case, USB charging cable, PSU incl. adapter for EU, US, UK, AU and 2 rechargeable lithium-polymer batteries                 </td> <td data-bbox="1238 1402 1396 1527">17-500-60-04</td> </tr> </tbody> </table>	MedLED Chrome MC 7	Item No.	bestehend aus: Stirnleuchte MedLED Chrome MC 7 (Hardtop), Transportkoffer, USB-Ladekabel, Netzteil inkl. Adapter EU, US, UK, AU und 2 Akkus (Lithium-Polymer)		consisting of: headlight MedLED Chrome MC 7 (hardtop), carrying case, USB charging cable, PSU incl. adapter for EU, US, UK, AU and 2 rechargeable lithium-polymer batteries	17-500-60-04
MedLED Chrome MC 7	Item No.						
bestehend aus: Stirnleuchte MedLED Chrome MC 7 (Hardtop), Transportkoffer, USB-Ladekabel, Netzteil inkl. Adapter EU, US, UK, AU und 2 Akkus (Lithium-Polymer)							
consisting of: headlight MedLED Chrome MC 7 (hardtop), carrying case, USB charging cable, PSU incl. adapter for EU, US, UK, AU and 2 rechargeable lithium-polymer batteries	17-500-60-04						
	<table border="1"> <thead> <tr> <th data-bbox="336 1603 1238 1641">MedLED Chrome MC 3/6/7</th> <th data-bbox="1238 1603 1396 1641">Item No.</th> </tr> </thead> <tbody> <tr> <td data-bbox="336 1641 1238 1747">                     bestehend aus:                      Stirnleuchte MedLED Chrome MC 3, MC 6, MC 7 (Hardtop), Transportkoffer, USB-Ladekabel, Netzteil inkl. Adapter EU, US, UK, AU und 2 Akkus (Lithium-Polymer)                 </td> <td data-bbox="1238 1641 1396 1747"></td> </tr> <tr> <td data-bbox="336 1747 1238 1872">                     consisting of:                      headlight MedLED Chrome MC 3, MC 6, MC 7 (hardtop), carrying case, USB charging cable, PSU incl. adapter for EU, US, UK, AU and 2 rechargeable lithium-polymer batteries                 </td> <td data-bbox="1238 1747 1396 1872">17-500-70-04</td> </tr> </tbody> </table>	MedLED Chrome MC 3/6/7	Item No.	bestehend aus: Stirnleuchte MedLED Chrome MC 3, MC 6, MC 7 (Hardtop), Transportkoffer, USB-Ladekabel, Netzteil inkl. Adapter EU, US, UK, AU und 2 Akkus (Lithium-Polymer)		consisting of: headlight MedLED Chrome MC 3, MC 6, MC 7 (hardtop), carrying case, USB charging cable, PSU incl. adapter for EU, US, UK, AU and 2 rechargeable lithium-polymer batteries	17-500-70-04
MedLED Chrome MC 3/6/7	Item No.						
bestehend aus: Stirnleuchte MedLED Chrome MC 3, MC 6, MC 7 (Hardtop), Transportkoffer, USB-Ladekabel, Netzteil inkl. Adapter EU, US, UK, AU und 2 Akkus (Lithium-Polymer)							
consisting of: headlight MedLED Chrome MC 3, MC 6, MC 7 (hardtop), carrying case, USB charging cable, PSU incl. adapter for EU, US, UK, AU and 2 rechargeable lithium-polymer batteries	17-500-70-04						



# MedLED Chrome

## Zubehör/Accessories

### Vergößerungslinsen MC 3 Magnifier lenses MC 3

Vergößerung Magnification	Dioptrin	Vergößerung	Erhöhung der Sehkraft	Optische Leistung	Empfohlener Arbeits- abstand (Brennweite) Recommended working distance (focal length)	Art.-Nr. Item No.
	Diopter	Magnification	Increase in eyesight	Optical power		
	+ 2	+ 0.40	40 %	1.4 x	250 mm	17-500-12-04
	+ 3	+ 0.60	60 %	1.6 x	220 mm	17-500-13-04
	+ 4	+ 0.80	80 %	1.8 x	200 mm	17-500-14-04

### Vergößerungslinsen MC 6 / MC 7 Magnifier lenses MC 6 / MC 7

Vergößerung Magnification	Dioptrin	Vergößerung	Erhöhung der Sehkraft	Optische Leistung	Empfohlener Arbeits- abstand (Brennweite) Recommended working distance (focal length)	Art.-Nr. Item No.
	Diopter	Magnification	Increase in eyesight	Optical power		
	+ 2	+ 0.40	40 %	1.4 x	250 mm	17-500-22-04
	+ 3	+ 0.60	60 %	1.6 x	220 mm	17-500-23-04
	+ 4	+ 0.80	80 %	1.8 x	200 mm	17-500-24-04

### Ladegerät Desktop charger

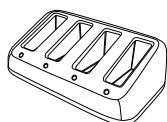

17-500-17-04

### Ersatzakkus (2 St.) Spare batteries, rechargeable (2 pcs.)

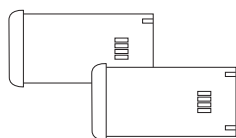

17-500-21-04

### Koffer Carrying case

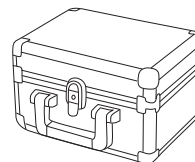

17-500-29-04

## MedLED Chrome Zubehör/Accessories

### Ersatzstirnbänder Spare head bands

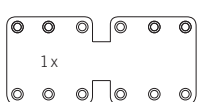

17-500-25-04  
Neoprene Snap-Around  
für/for Hardtop

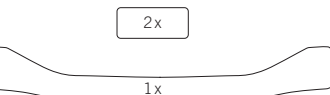
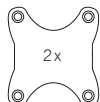

17-500-26-04  
Neoprene Velcro  
für/for Hardtop

17-500-27-04  
Soft Pillow Velcro  
für/for Hardtop

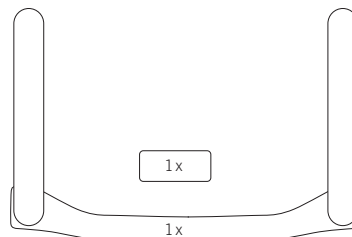

17-500-28-04  
Soft Pillow Velcro  
für/for Softtop

### GoPro Adapter

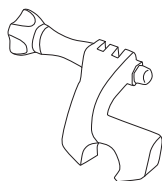

17-500-31-04

### Ersatzkopfband Spare headstrap

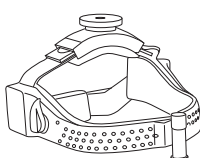

17-500-32-04  
Hardtop

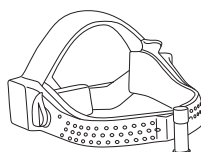

17-500-33-04  
Softtop

### Gelbfilter (für Dental) Amber filter (for Dental)



17-500-34-04  
MC 3



17-500-35-04  
MC 6

### Leuchtkörper Bezel

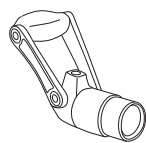

17-500-41-04  
MC 3



17-500-51-04  
MC 6

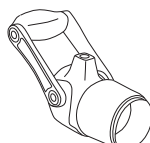

17-500-61-04  
MC 7

### Ladegerät/Netzstecker Desktop charger/Mains plug

		Art.-Nr. / Item No.	
		EU	17-500-01-04
		US	17-500-02-04
		UK	17-500-03-04
		AU	17-500-04-04

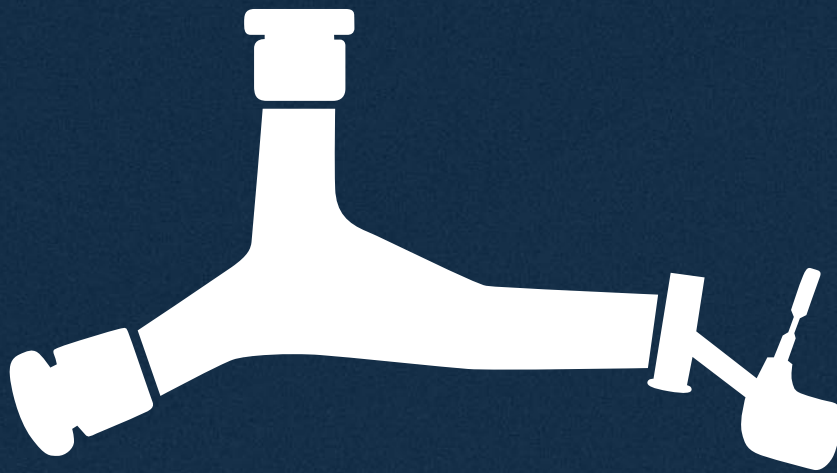

truly cordless™

## KLS Martin Group

### **KLS Martin Australia Pty Ltd.**

Sydney · Australia  
Tel. +61 2 9439 5316  
australia@klsmartin.com

### **KLS Martin India Pvt Ltd.**

Chennai · India  
Tel. +91 44 66 442 300  
india@klsmartin.com

### **Martin Nederland/Marned B.V.**

Huizen · The Netherlands  
Tel. +31 35 523 45 38  
nederland@klsmartin.com

### **KLS Martin LP**

Jacksonville · Florida, USA  
Tel. +1 904 641 77 46  
usa@klsmartin.com

### **KLS Martin do Brasil Ltda.**

São Paulo · Brazil  
Tel. +55 11 3554 2299  
brazil@klsmartin.com

### **Martin Italia S.r.l.**

Milan · Italy  
Tel. +39 039 605 67 31  
italia@klsmartin.com

### **Gebrüder Martin GmbH & Co. KG**

Moscow · Russia  
Tel. +7 499 792-76-19  
russia@klsmartin.com

### **Gebrüder Martin GmbH & Co. KG**

Shanghai · China  
Tel. +86 21 5820 6251  
china@klsmartin.com

### **Nippon Martin K.K.**

Tokyo · Japan  
Tel. +81 3 3814 1431  
nippon@klsmartin.com

### **Gebrüder Martin GmbH & Co. KG**

Dubai · United Arab Emirates  
Tel. +971 4 454 16 55  
middleeast@klsmartin.com

### **KLS Martin France SARL**

Mulhouse · France  
Tel. +33 3 8951 3150  
france@klsmartin.com

### **KLS Martin SE Asia Sdn. Bhd.**

Penang · Malaysia  
Tel. +604 505 7838  
malaysia@klsmartin.com

### **KLS Martin UK Ltd.**

London · United Kingdom  
Tel. +44 1189 000 570  
uk@klsmartin.com

### **Gebrüder Martin GmbH & Co. KG**

#### **A company of the KLS Martin Group**

KLS Martin Platz 1 · 78532 Tuttlingen · Germany  
P.O. Box 60 · 78501 Tuttlingen · Germany  
Tel. +49 7461 706-0 · Fax +49 7461 706-193  
info@klsmartin.com · www.klsmartin.com

