



marTract[®]

Retractor System



Maximum exposure, versatility and flexibility are the key factors for efficient surgical procedures and downstreaming process and OT budgets. The marTract® is the perfect system for that.

marTract® Retractor System

“Surgical Innovation is our Passion”:

The guiding principle of the KLS Martin Group. Above all stands the pursuit of continuous leadership in innovation, to provide efficient and safe products for the OR. Condor® with its target “achieving more” committed to this vision.

Through shared passion for innovation and quality “Made in Germany” a cooperation has emerged. A connection helping everyone, doing the next efficient step.

Achieving more together - with KLS Martin and Condor® MedTec GmbH.

KLS martin
GROUP



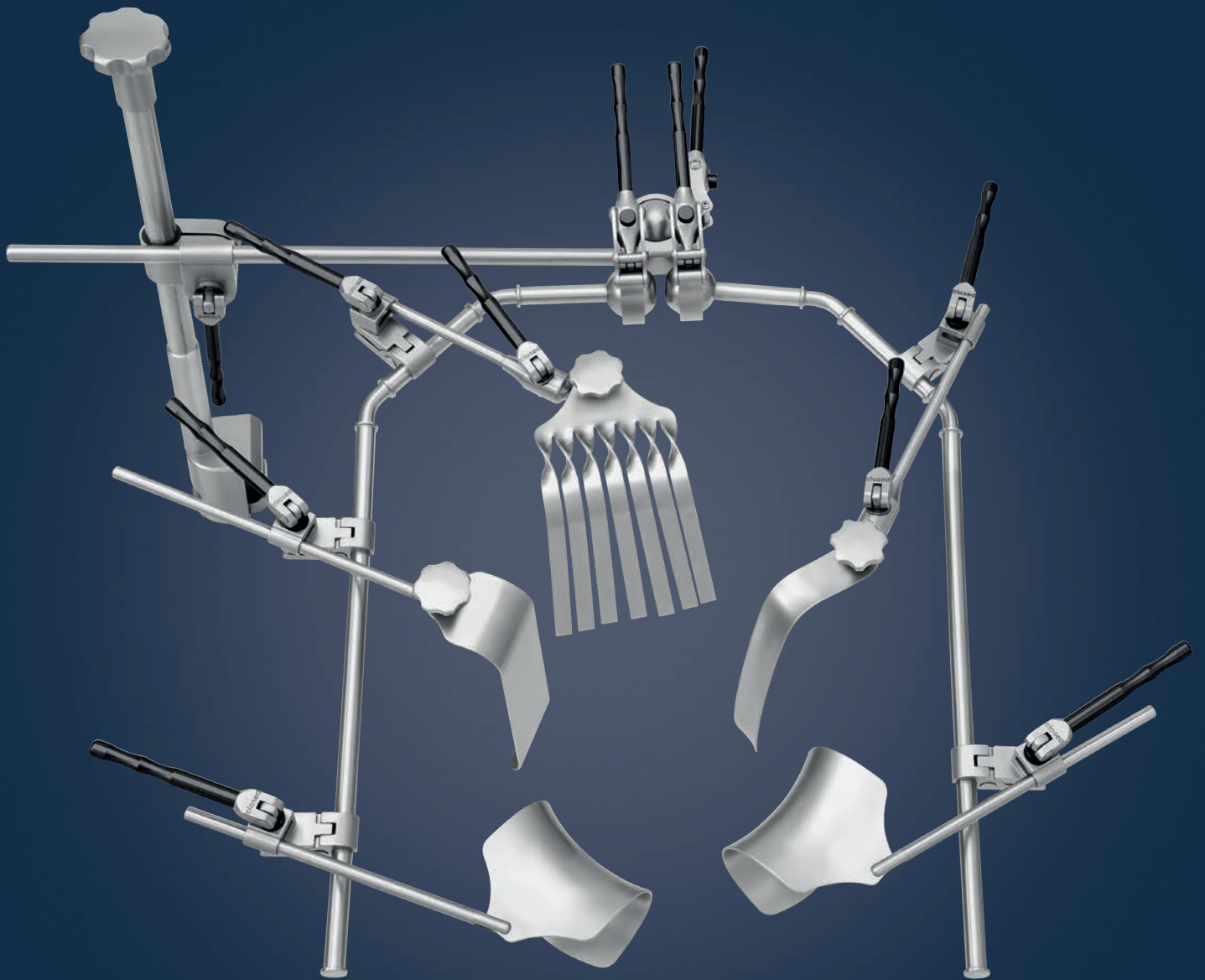
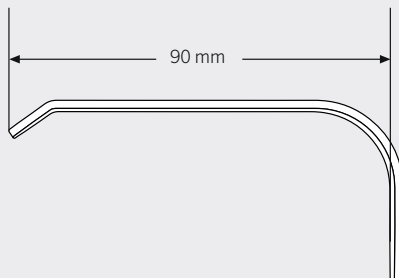

Table of Contents

	Pages
Introduction	2-5
Feature, Function and Benefit	6-7
marTract® Standard	8-23
marTract® Obesity	26-31
marTract® Compact	32-41
Reprocessing	42-43
Retractor Components	44-65
Index of Order Numbers	66

Supplementary catalog explanations

Blade dimensions: **blade depth x blade width**
Example: 15-921-50-07, **90 mm x 40 mm**



Feature, Function and Benefit

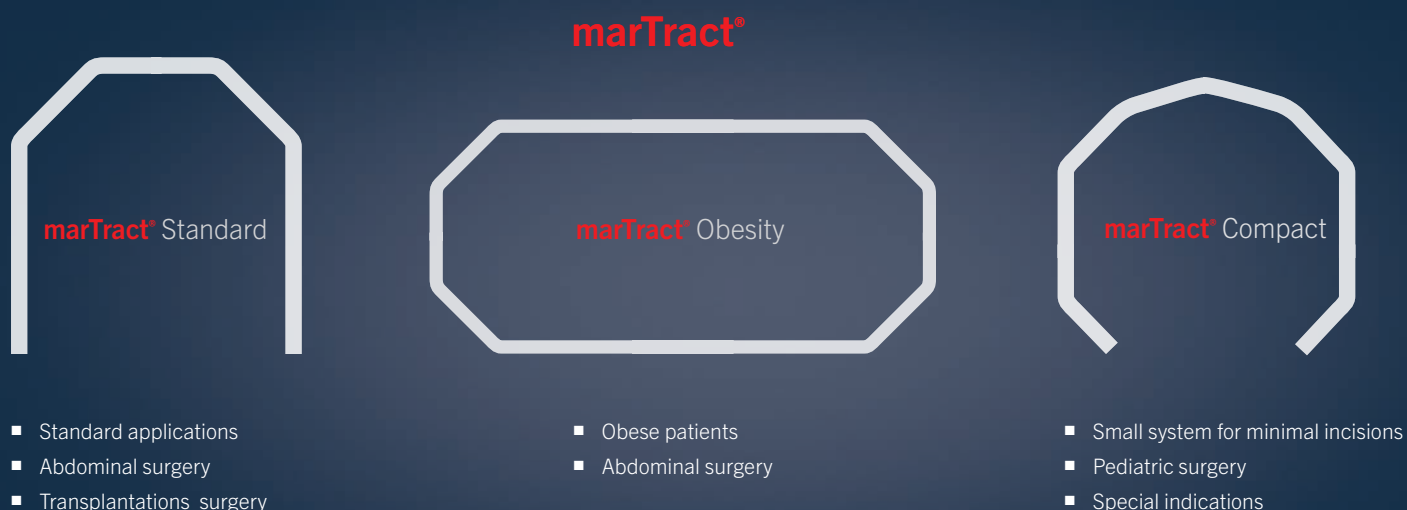

One system – endless modifications and flexibility

The marTract® retractor system is a modular product for a variety of indications and applications in surgery. Its flexibility and the compatibility of all components allow an interdisciplinary use for almost all tasks. This finally ends not only in reducing the working load of the OT staff but also in minimizing operating procedures and budgets.

The system consists minimum of two parts: a basic frame set for different indications and specific extension sets with retractor blades and special parts applied for individual indications or disciplines. Moreover, customized configurations based on the single components are possible as well.

The interaction of the individual components – the success factor of the marTract® Systems

marTract®

Electrical safety

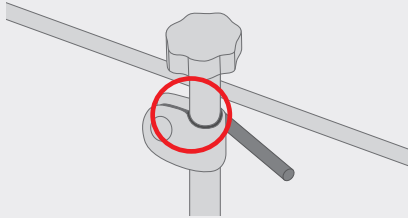

Feature

- The integrated insulation (black ring in the clamp).

Benefit

- Eliminates risk to the patient from high-frequency current leakage.

3-D adjustment

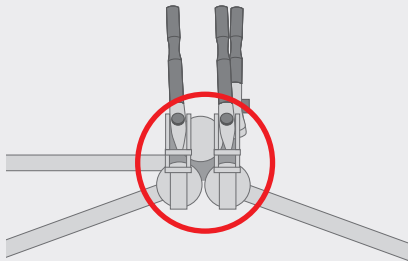

- Retainer with the three-ball joint brackets.

- Ideal exposure in all situations.

In-depth site setting

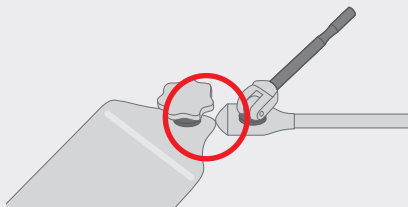

- Patented blade holders.

- Ensure an optimal in-depth adjustment, tip-focused, incl. sideways and inwards moveable blades.

Quick mounting / simple operation

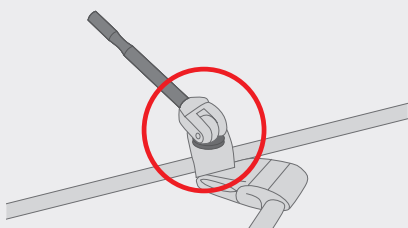

- Soft clamps with eccentric closure.

- Quick mounting by clicking and fast positioning.

Reprocessing

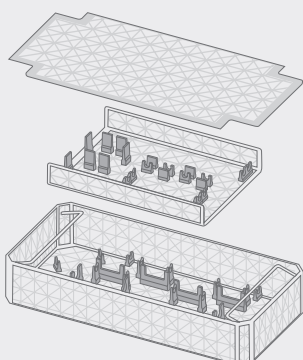

- Disassembly possible.
- For each set suggestion a principle storage solution.

- Perfect adaption for cleaning and disinfection.

marTract® Standard

The marTract® standard offers the widest range of applicable disciplines, from simple indications up to complex liver transplantation.

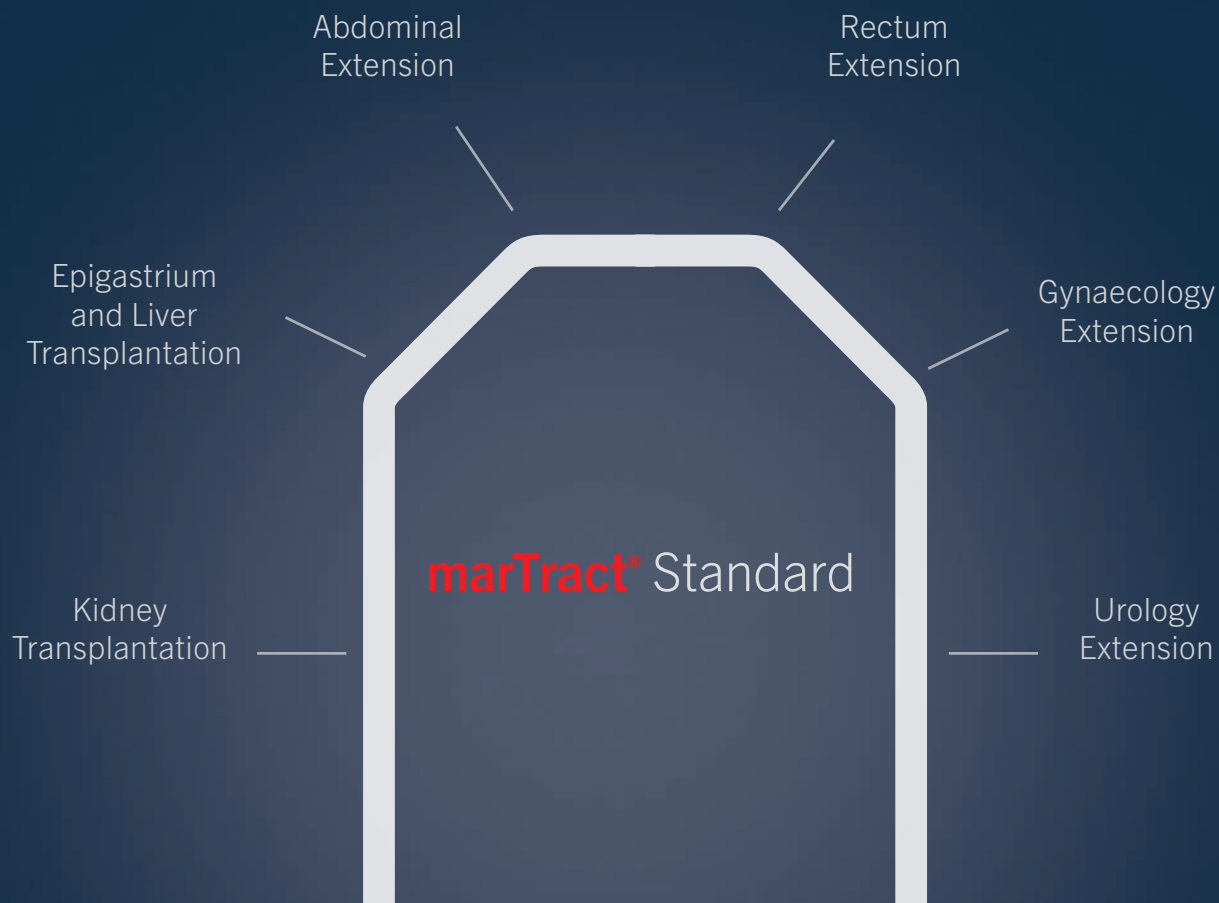

Abdominal Surgery

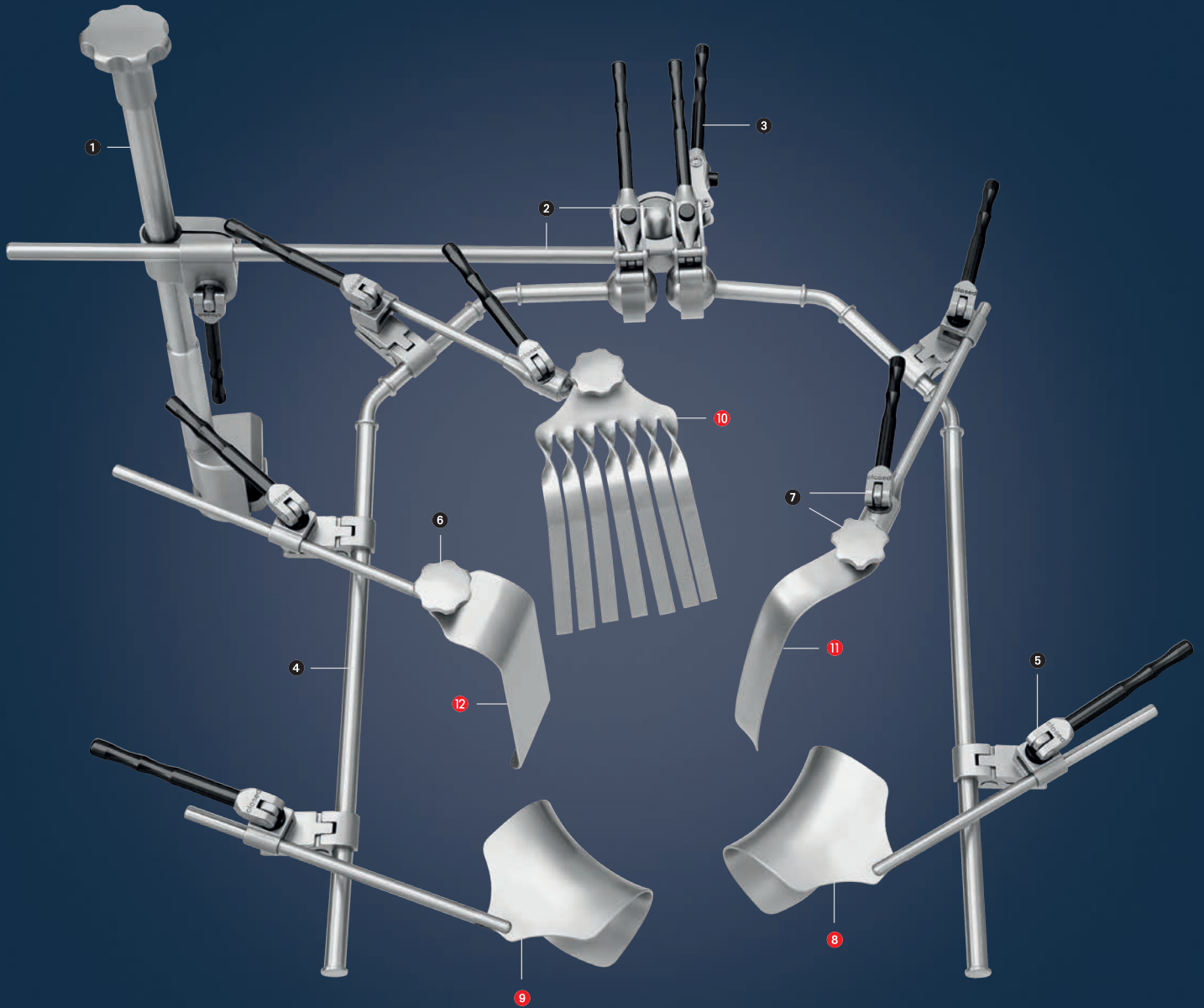

Abdominal Surgery

The abdominal set consists of the standard frame set and the extension for abdominal surgery.

15-924-00-04		marTract® frame standard consisting of	Qty.
15-920-10-07	①	bracket, operating table	1
15-920-30-07	②	transverse rod for 15-920-34-07	1
15-920-34-07	③	ball mount for holding arms	1
15-920-22-07	④	holding arm, standard system	2
15-920-35-07	⑤	fixing clip for retractor	6
15-920-40-07	⑥	blade holder, fixed	3
15-920-42-07	⑦	blade holder, movable	1

15-924-10-04*		marTract® abdominal extension consisting of	Qty.
15-921-32-07	⑧	Kirschner, retractor, 78 x 65 mm	2
15-921-31-07	⑨	Kirschner, retractor, 85 x 60 mm	2
15-922-40-07	⑩	fan, blade, flexible, 140 x 90 mm	1
15-922-32-07	⑪	Breisky, blade, 150 x 25 mm	1
15-921-51-07	⑫	Langenbeck, blade, 150 x 50 mm	1
15-921-10-07		blade, flexible, 160 x 50 mm	1
15-921-13-07		blade, flexible, 160 x 75 mm	1
15-921-70-07		Deaver, blade, 150 x 50 mm	1

* Picture is not showing the complete set

Additional optional sets

Abdominal Gynaecology

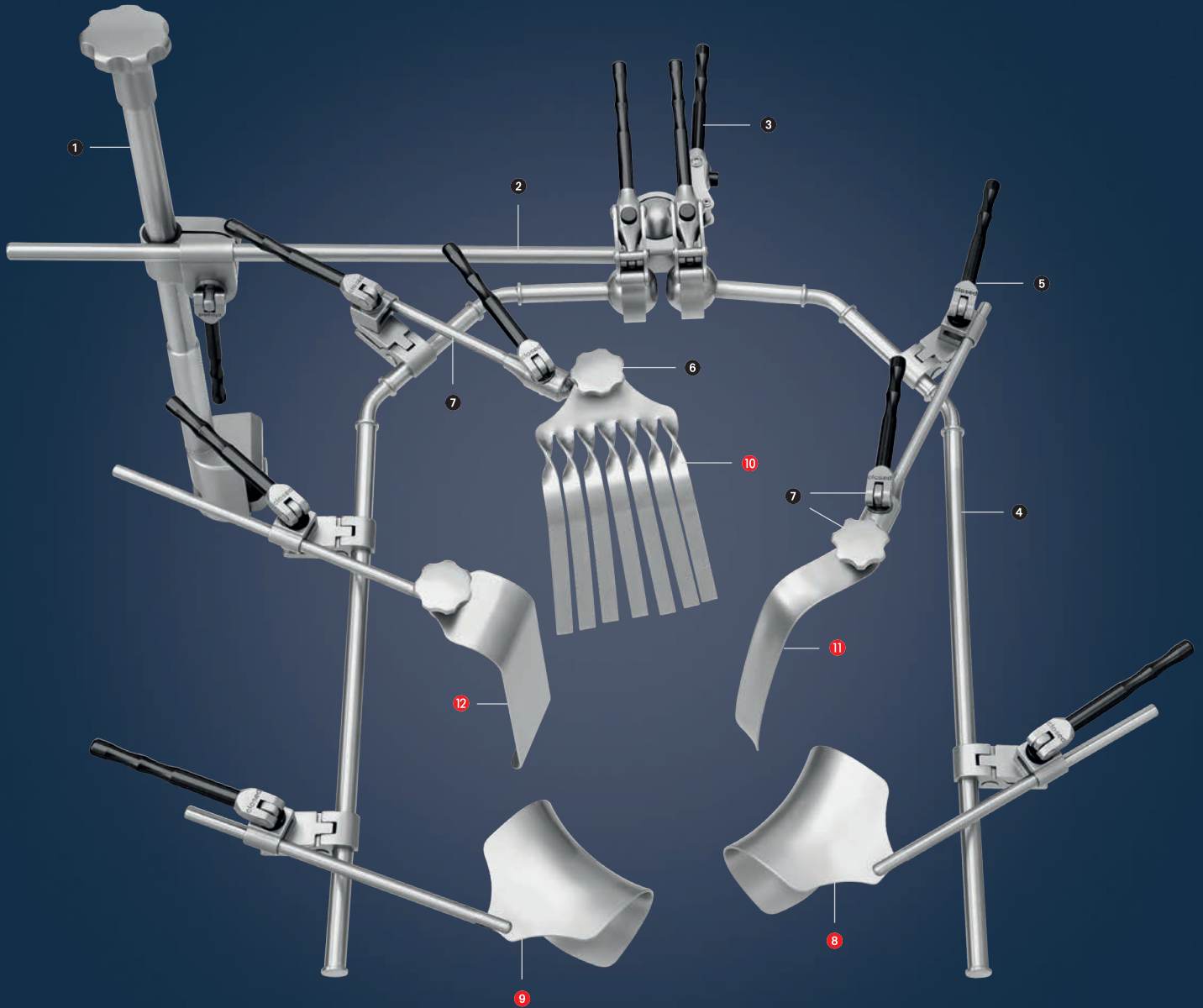

Abdominal Gynaecology

The abdominal system for gynaecology consists of the standard frame and the extension for gynaecology.

15-924-00-04		marTract® frame standard consisting of	Qty.
15-920-10-07	①	bracket, operating table	1
15-920-30-07	②	transverse rod for 15-920-34-07	1
15-920-34-07	③	ball mount for holding arms	1
15-920-22-07	④	holding arm, standard system	2
15-920-35-07	⑤	fixing clip for retractor	6
15-920-40-07	⑥	blade holder, fixed	3
15-920-42-07	⑦	blade holder, movable	1

15-924-11-04 *		marTract® gynaecology extension consisting of	Qty.
15-921-32-07	⑧	Kirschner, retractor, 78 x 65 mm	2
15-921-31-07	⑨	Kirschner, retractor, 85 x 60 mm	2
15-922-40-07	⑩	fan, blade, flexible, 140 x 90 mm	1
15-922-32-07	⑪	Breisky, blade, 150 x 25 mm	1
15-921-51-07	⑫	Langenbeck, blade, 150 x 50mm	1
15-921-10-07		blade, flexible, 160 x 50 mm	1
15-921-13-07		blade, flexible, 160 x 75 mm	1
15-921-70-07		Deaver, blade, 150 x 50 mm	1
15-922-33-07		Breisky, blade, 200 x 25 mm	1

* Picture is not showing the complete set

Additional optional sets

Urology

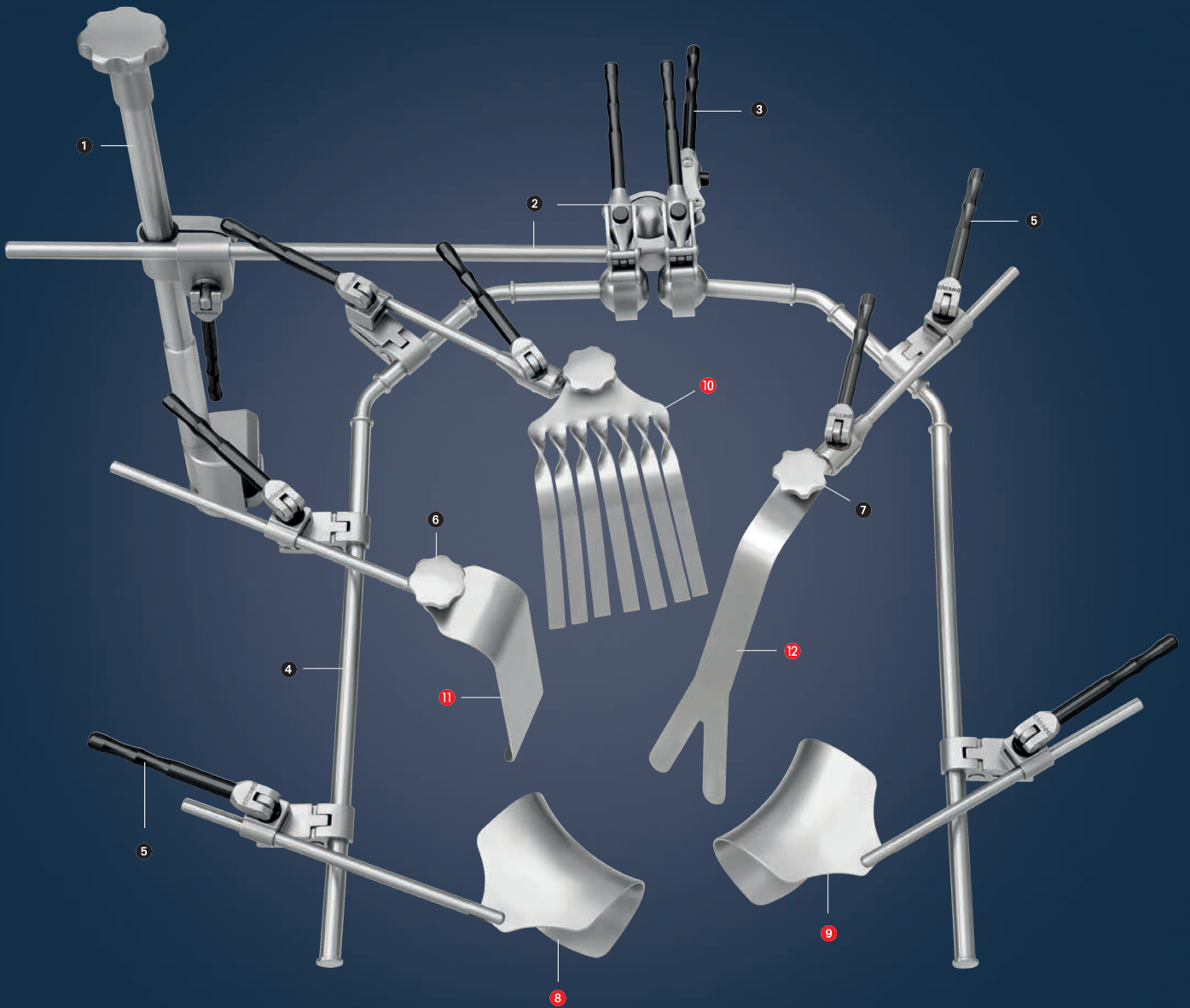

Urology

The urology system consists of the standard frame and the extension for urology.

15-924-00-04		marTract® frame standard consisting of	Qty.
15-920-10-07	❶	bracket, operating table	1
15-920-30-07	❷	transverse rod for 15-920-34-07	1
15-920-34-07	❸	ball mount for holding arms	1
15-920-22-07	❹	holding arm, standard system	2
15-920-35-07	❺	fixing clip for retractor	6
15-920-40-07	❻	blade holder, fixed	3
15-920-42-07	❼	blade holder, movable	1

15-924-12-04 *		marTract® extension urology consisting of	Qty.
15-921-32-07	❸	Kirschner, retractor, 78 x 65 mm	2
15-921-31-07	❹	Kirschner, retractor, 85 x 60 mm	2
15-922-40-07	❺	fan, blade, flexible, 140 x 90 mm	1
15-922-32-07		Breisky, blade, 150 x 25 mm	1
15-921-51-07	❻	Langenbeck, blade, 150 x 50 mm	1
15-921-10-07		blade, flexible, 160 x 50 mm	1
15-921-13-07		blade, flexible, 160 x 75 mm	1
15-921-70-07		Deaver, blade, 150 x 50 mm	1
15-922-01-07	❼	bladder, blade, flexible, 150 x 80 mm	1

* Picture is not showing the complete set

Additional optional sets

Abdominal Rectal Surgery

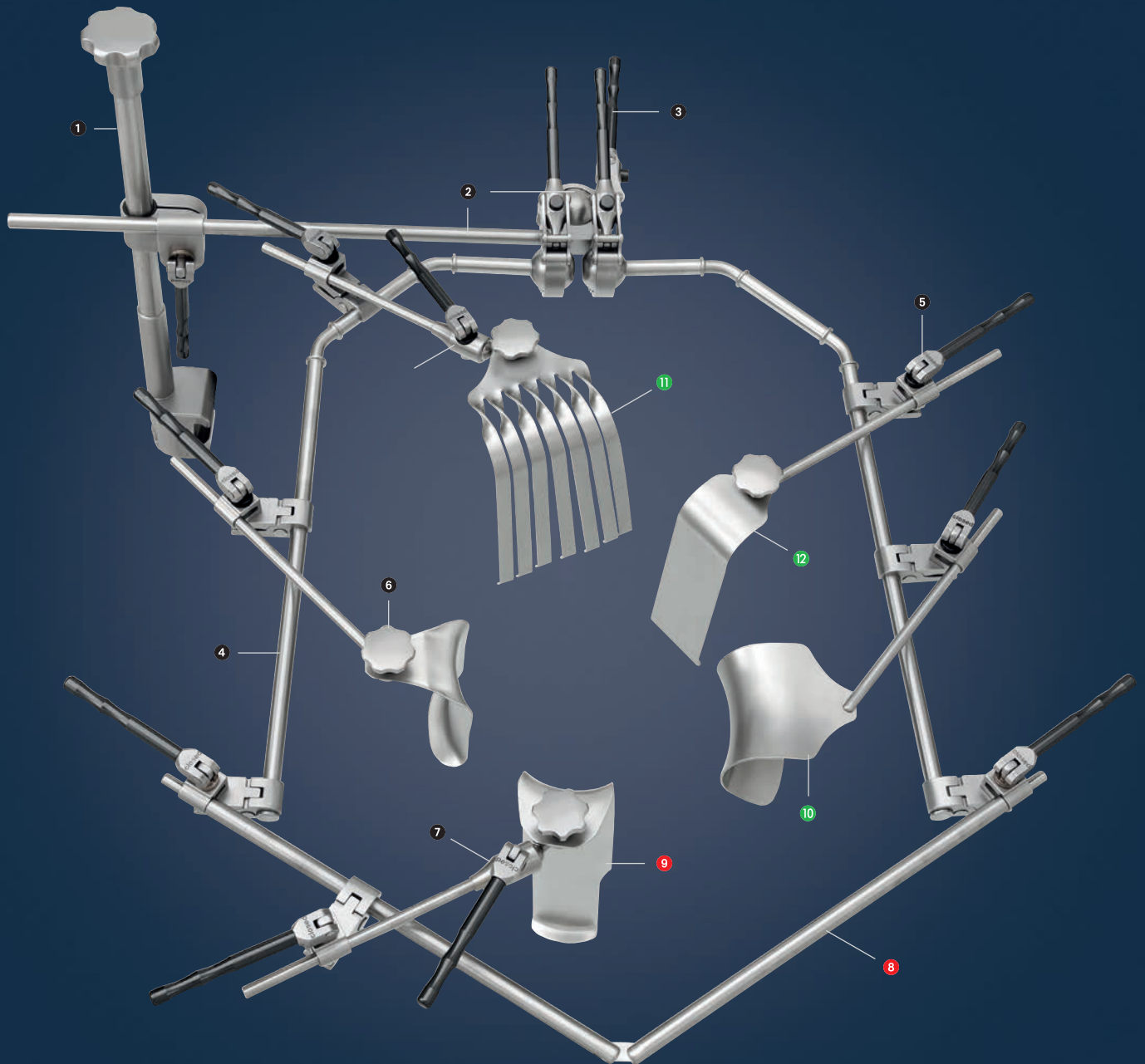

Abdominal Rectal Surgery

The rectal surgery system consists of the standard frame, the abdominal extension and the extension for rectum surgery.

15-924-00-04		marTract® frame standard consisting of	Qty.
15-920-10-07	❶	bracket, operating table	1
15-920-30-07	❷	transverse rod for 15-920-34-07	1
15-920-34-07	❸	ball mount for holding arms	1
15-920-22-07	❹	holding arm, standard system	2
15-920-35-07	❺	fixing clip for retractor	6
15-920-40-07	❻	blade holder, fixed	3
15-920-42-07	❼	blade holder, movable	1

15-924-13-04 *		marTract® extension rectum surgery consisting of	Qty.
15-920-31-07	❸	extension for rectum add-on	1
15-920-35-07		fixing clip for retractor	2
15-922-60-07	❹	pelvis, St.Marks, blade, 174 x 60 mm	1
15-922-61-07		pelvis, St.Marks, blade, 270 x 60 mm	1
15-922-33-07		Breisky, blade, 200 x 25 mm	1
15-922-34-07		Breisky, blade, 250 x 25 mm	1
15-921-12-07		blade, flexible, spatula, 300 x 50 mm	1

15-924-10-04 *		marTract® abdominal extension consisting of	Qty.
15-921-32-07	❿	Kirschner, retractor, 78 x 65 mm	2
15-921-31-07		Kirschner, retractor, 85 x 60 mm	2
15-922-40-07	⓫	fan, blade, flexible, 140 x 90 mm	1
15-922-32-07		Breisky, blade, 150 x 25 mm	1
15-921-51-07	⓬	Langenbeck, blade, 150 x 50 mm	1
15-921-10-07		blade, flexible, 160 x 50 mm	1
15-921-13-07		blade, flexible, 160 x 75 mm	1
15-921-70-07		Deaver, blade, 150 x 50 mm	1

* Picture is not showing the complete set

Additional optional sets

Kidney Transplantation

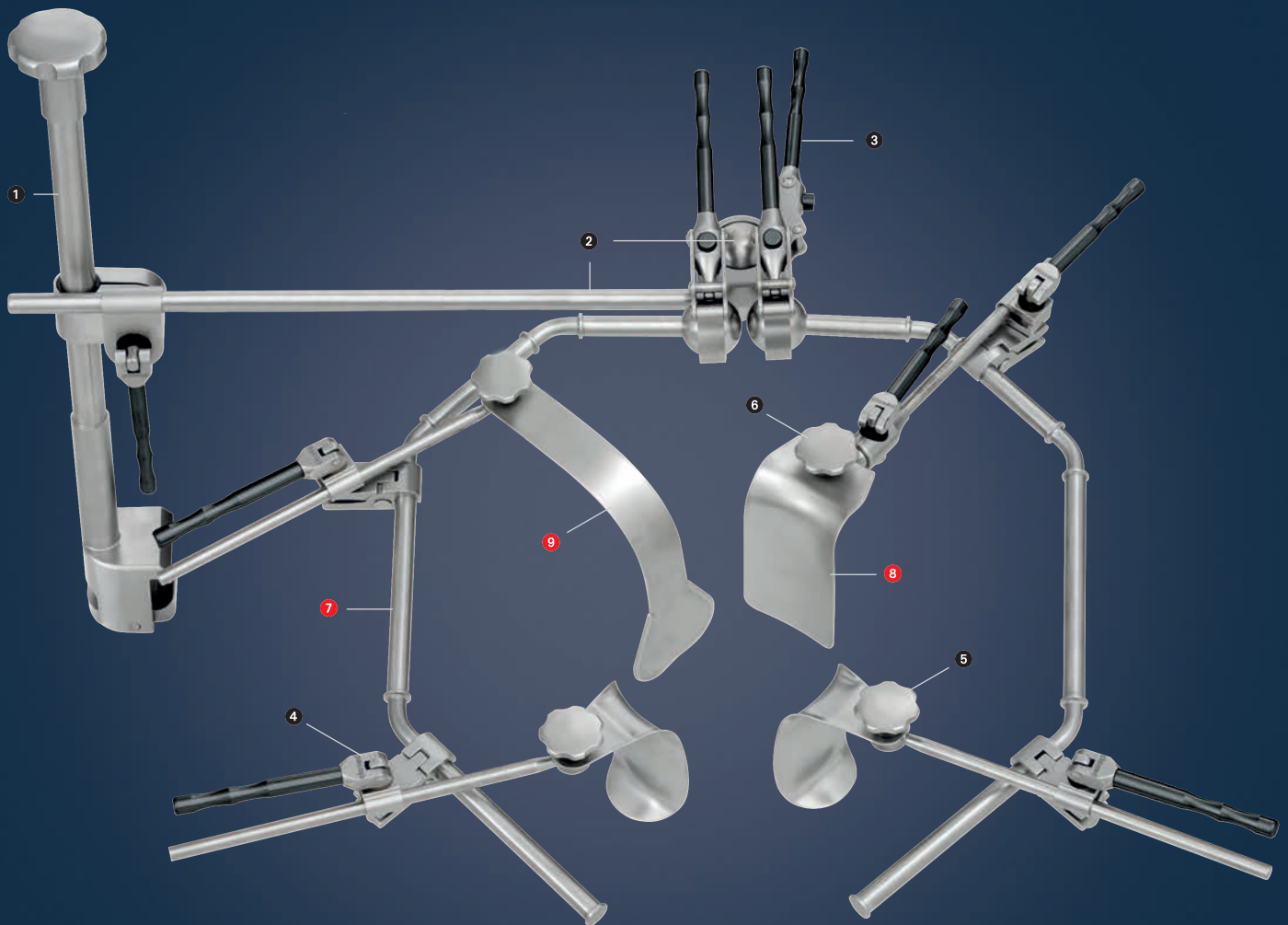

Kidney Transplantation

The kidney transplantation system consists of the standard frame and the extension for kidney.

15-924-00-04		marTract® frame standard consisting of	Qty.
15-920-10-07	①	bracket, operating table	1
15-920-30-07	②	transverse rod for 15-920-34-07	1
15-920-34-07	③	ball mount for holding arms	1
15-920-22-07		holding arm, standard system	2
15-920-35-07	④	fixing clip for retractor	6
15-920-40-07	⑤	blade holder, fixed	3
15-920-42-07	⑥	blade holder, movable	1

15-924-14-04 *		marTract® extension kidney consisting of	Qty.
15-920-21-07	⑦	holding arm for kidney add-on	2
15-920-42-07		blade holder, movable	1
15-921-30-07		Kirschner, retractor, 65 x 50 mm	2
15-921-50-07		Langenbeck, blade, 90 x 40 mm	1
15-921-51-07		Langenbeck, blade, 150 x 50 mm	1
15-921-10-07	⑧	blade, flexible, 160 x 50 mm	1
15-921-13-07		blade, flexible, 160 x 75 mm	1
15-922-31-07		Breisky, blade, 110 x 25 mm	1
15-922-32-07		Breisky, blade, 150 x 25 mm	1
15-922-33-07		Breisky, blade, 200 x 25 mm	1
15-922-10-07	⑨	Harrington, blade, 175 x 50 mm	1
15-922-11-07		Harrington, blade, 175 x 65 mm	1
15-922-20-07		retractor, slotted, 125 x 50 mm	1

* Picture is not showing the complete set

Additional optional sets

Epigastrium Set/Liver Transplantation

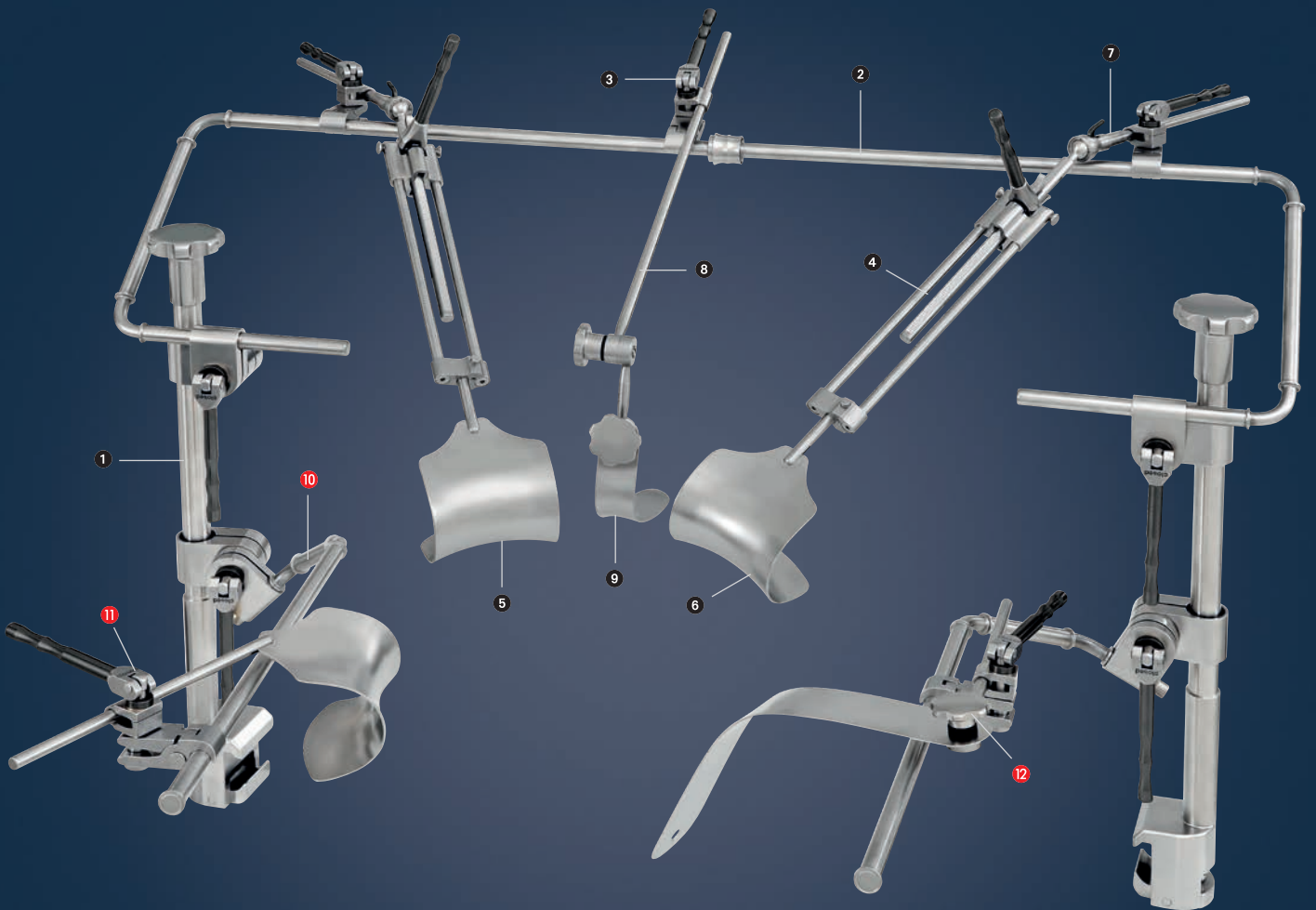

Epigastrium Set/Liver Transplantation

The epigastrium system consists of the epigastric extension.

For liver transplantation the extension for abdominal liver is needed additionally.

15-924-20-04		marTract® liver epigastrium consisting of	Qty.
15-920-11-07	①	bracket, op.table, epigastrium	2
15-920-50-07	②	retainer for epigastrium	1
15-920-33-07		spacer for radial piston	2
15-920-35-07	③	fixing clip for retractor	4
15-920-51-07	④	pulling device for epigastrium	2
15-922-90-07	⑤	epigastrium, retractor, 85 x 60 mm	2
15-922-91-07	⑥	epigastrium, retractor, 78 x 65 mm	2
15-920-43-07	⑦	blade holder for epigastrium add-on	2
15-920-45-07	⑧	blade holder, with stop, 40 cm	1
15-922-32-07	⑨	Breisky, blade, 150 x 25 mm	1
15-922-10-07		Harrington, blade, 175 x 50 mm	1
15-921-51-07		Langenbeck, blade, 150 x 50 mm	1

15-924-21-04 *		marTract® liver abdominal consisting of	Qty.
15-920-24-07	⑩	holding arm for liver add-on	2
15-920-35-07	⑪	fixing clip for retractor	4
15-920-40-07	⑫	blade holder, fixed	2
15-920-42-07		blade holder, movable	1
15-921-32-07		Kirschner, retractor, 78 x 65 mm	2
15-921-31-07		Kirschner, retractor, 85 x 60 mm	2
15-922-40-07		fan, blade, flexible, 140 x 90 mm	1
15-921-52-07		Langenbeck, blade, 200 x 50 mm	1
15-922-11-07		Harrington, blade, 175 x 65 mm	1
15-921-10-07		blade, flexible, 160 x 50 mm	1

* Picture is not showing the complete set

Additional optional sets

Laparoscopic Liver Retractor

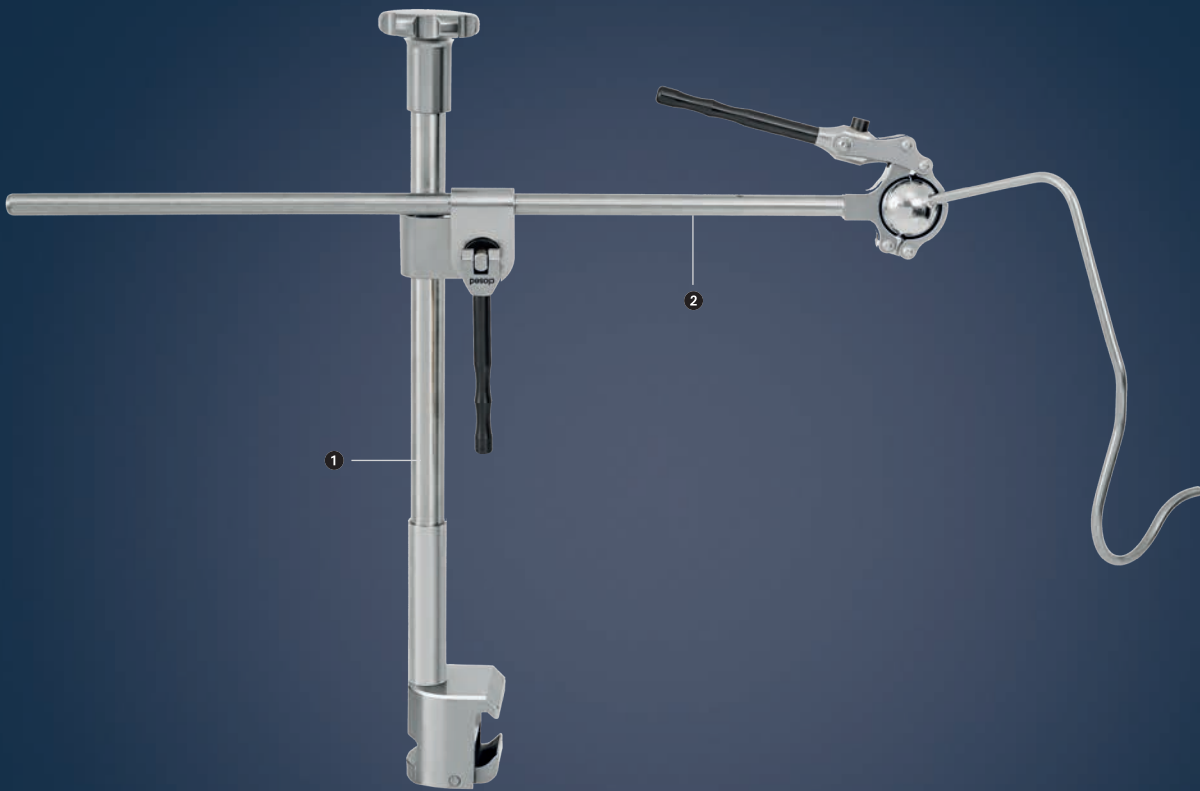

Laparoscopic Liver Retractor

The laparoscopic retractor is used to retract the liver during laparoscopic upper abdominal surgeries. At the same time, the liver is protected from the rest of the situs as well as from the procedure itself.

		marTract® laparoscopic liver retractor consisting of	Qty.
15-920-10-07	❶	bracket, operating table	1
15-920-90-07	❷	fixation arm for laparoscopic liver hooklet	1
15-922-95-07		laparoscopic liver hooklet / size M	1
15-922-96-07		laparoscopic liver hooklet / size L	1
15-920-33-07		spacer for radial piston	1

MIDCAB Retractor

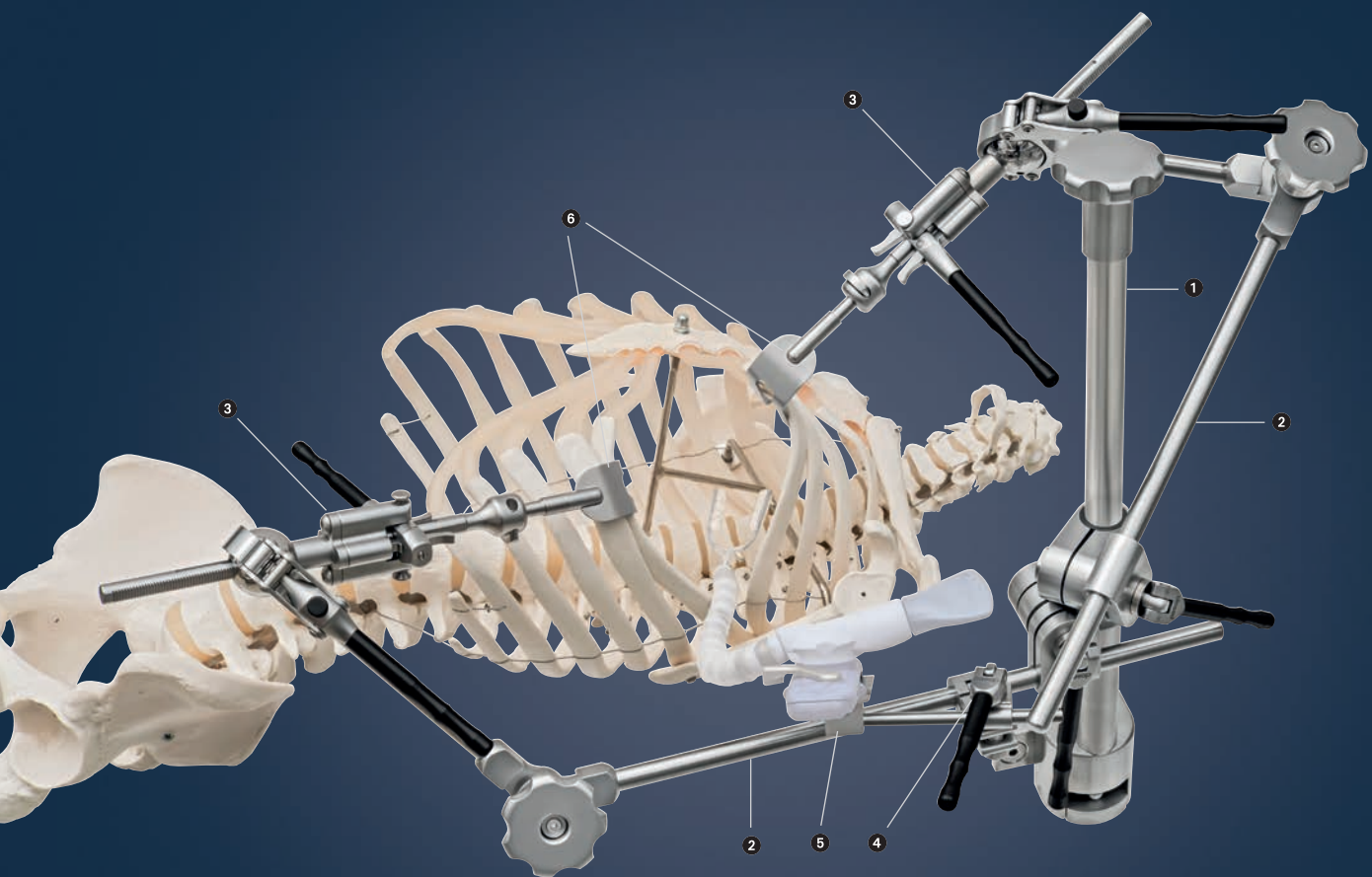

MIDCAB (Minimally Invasive Direct Coronary Artery Bypass)

The MIDCAB system is used in particular to perform minimally invasive direct coronary artery bypasses. Due to its flexibility, only one retractor system instead of two different is required for this procedure.

15-924-46-04		marTract system, MIDCAB consisting of	Qty.
15-920-12-07	①	bracket, operating table, MIDCAB	1
15-920-25-07	②	holding arm, with angle, MIDCAB	2
15-920-52-07	③	pulling device, MIDCAB	2
15-920-35-07	④	fixing clip for retractor	2
15-920-47-07	⑤	adapter, tissue stabilizer	1
15-923-21-07	⑥	retractor, MIDCAB, 2-pronged, 40 x 30 mm	2
15-923-22-07		retractor, MIDCAB, 2-pronged, 50 x 30 mm	2
15-923-23-07		retractor, MIDCAB, 2-pronged, 60 x 30 mm	2
15-923-24-07		wound retractor, MIDCAB, 42 x 36 mm	2
15-923-25-07		wound retractor, MIDCAB, 65 x 38 mm	2
15-923-26-07		wound retractor, MIDCAB, 65 x 50 mm	2
15-923-27-07		wound retractor, MIDCAB, 70 x 50 mm	2
15-923-28-07		wound retractor, MIDCAB, 92 x 51 mm	2
15-923-29-07		wound retractor, MIDCAB, 103 x 51 mm	2
15-923-30-07		wound retractor, MIDCAB, 42 x 57 mm	2
15-923-31-07		wound retractor, MIDCAB, 65 x 57 mm	2

		marTract® MIDCAB accessor optional y	Qty.
15-920-46-07		bracket, optics, flexible	1

* Picture is not showing the complete set

Additional optional sets

Tissue Stabilizer not available from KLS Martin

marTract® Obesity

The marTract® obesity system is especially designed for “big” tasks in retraction of body and tissues. Due to its versatility, coming from doubled marTract® standard, it is as easy to use as the other systems.

Abdominal
Extension



marTract® Obesity



Extension
Gynaecology

Abdominal Obesity

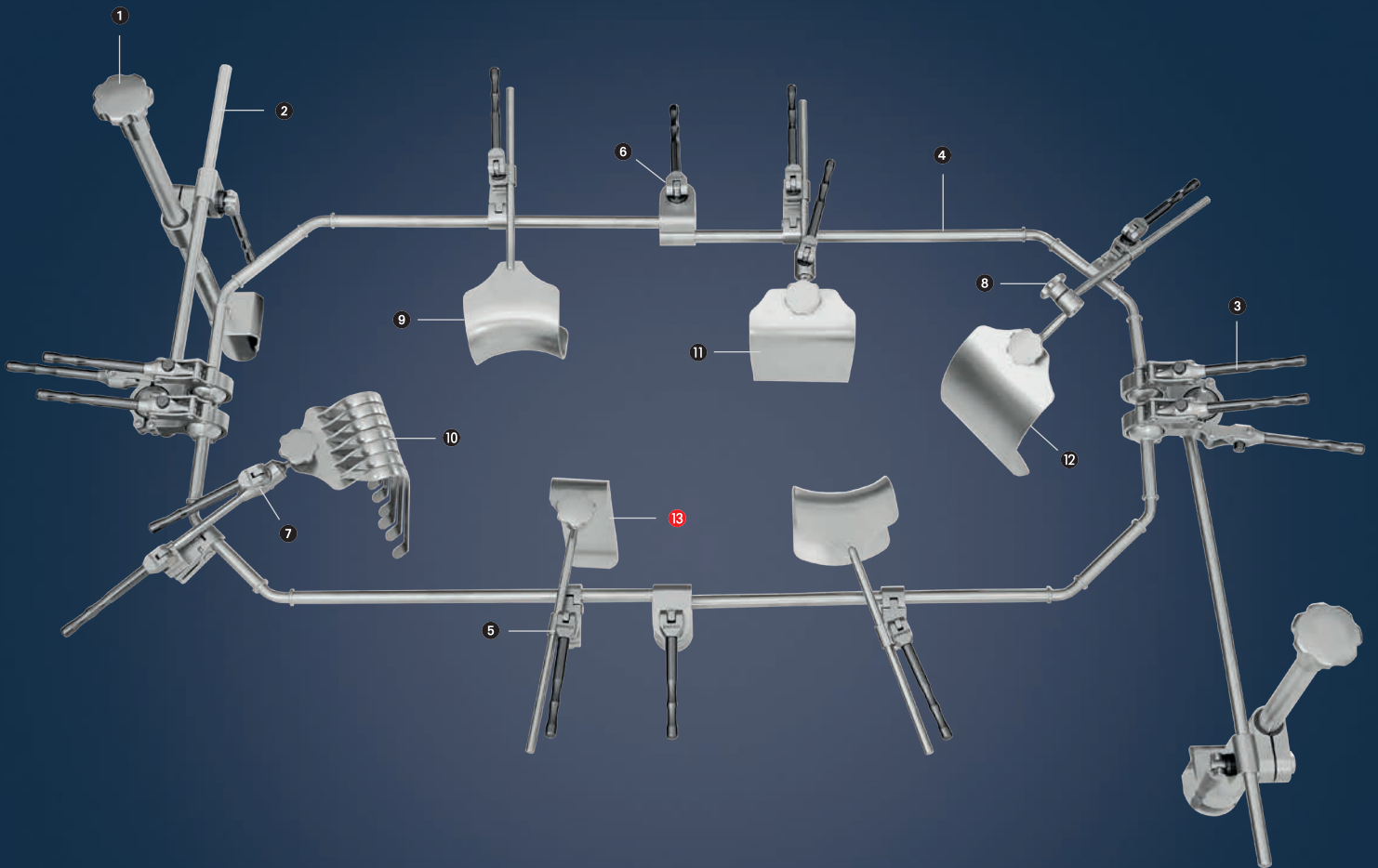

Abdominal Obesity

The abdominal obesity system consists of the obesity frame and the extension for obese surgery.

15-924-30-04		marTract® frame obesity consisting of	Qty.
15-920-10-07	❶	bracket, operating table	2
15-920-30-07	❷	transverse rod for 15-920-34-07	2
15-920-34-07	❸	ball mount for holding arms	2
15-920-23-07	❹	holding arm, obesity system	4
15-920-35-07	❺	fixing clip for retractor	10
15-920-32-07	❻	connector for obesity system	2
15-920-33-07		spacer for radial piston	2
15-920-42-07	❼	blade holder, movable	2
15-920-44-07	❽	blade holder, with stop, 20 cm	2
15-921-33-07	❾	Kirschner, retractor, 90 x 80 mm	4
15-922-41-07	❿	fan, blade, flexible, 165 x 90 mm	1
15-921-02-07	⓫	intestine blade, wide, 200 x 100 mm	1
15-921-03-07		intestine blade, wide, 250 x 100 mm	1
15-921-71-07		Deaver, blade, 200 x 70 mm	1
15-921-72-07	⓬	Deaver, blade, 220 x 100 mm	1

15-924-31-04 *		marTract® extension abdominal obesity consisting of	Qty.
15-920-45-07		blade holder, with stop, 40 cm	1
15-921-01-07		intestine blade, wide, 150 x 100 mm	2
15-921-52-07	⓭	Langenbeck, blade, 200 x 50 mm	2

* Picture is not showing the complete set

Additional optional sets

Gynaecological Obesity

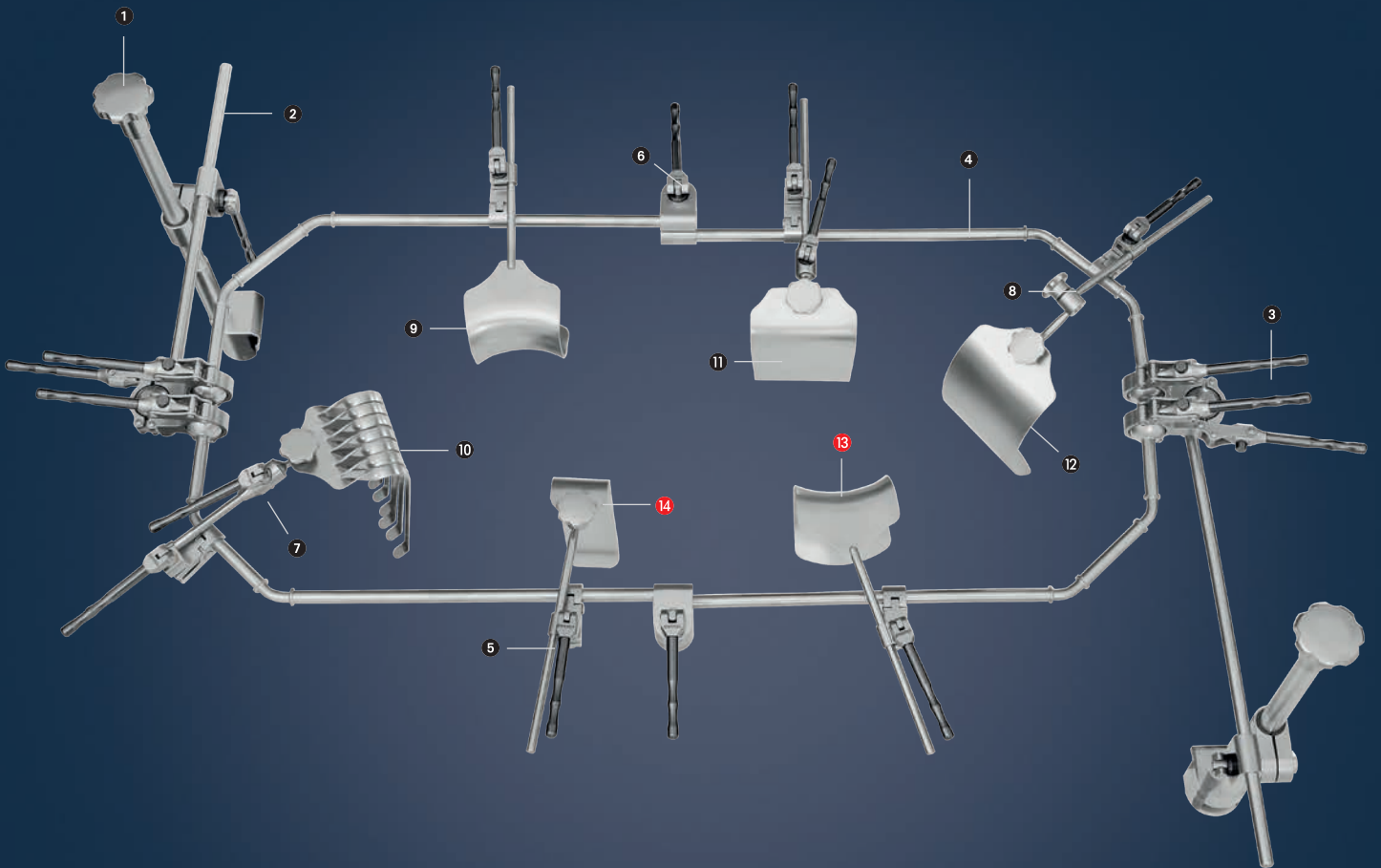

Gynaecological Obesity

The gynaecological obesity system consists of the obesity frame, the extension gynaecology obesity and the extension gynaecology.

15-924-30-04		marTract® frame obesity consisting of	Qty.
15-920-10-07	❶	bracket, operating table	2
15-920-30-07	❷	transverse rod for 15-920-34-07	2
15-920-34-07	❸	ball mount for holding arms	2
15-920-23-07	❹	holding arm, obesity system	4
15-920-35-07	❺	fixing clip for retractor	10
15-920-32-07	❻	connector for obesity system	2
15-920-33-07		spacer for radial piston	2
15-920-42-07	❼	blade holder, movable	2
15-920-44-07	❽	blade holder, with stop, 20 cm	2
15-921-33-07	❾	Kirschner, retractor, 90 x 80 mm	4
15-922-41-07	❿	fan, blade, flexible, 165 x 90 mm	1
15-921-02-07	⓫	intestine blade, wide, 200 x 100 mm	1
15-921-03-07		intestine blade, wide, 250 x 100 mm	1
15-921-71-07		Deaver, blade, 200 x 70 mm	1
15-921-72-07	⓬	Deaver, blade, 220 x 100 mm	1

15-924-32-04 *		marTract® extension gynaecological obesity consisting of	Qty.
15-921-71-07		Deaver, blade, 200 x 70 mm	1
15-921-72-07		Deaver, blade, 220 x 100 mm	1
15-921-80-07		Deaver, retractor, 200 x 70 mm	2

15-924-11-04 *		marTract® extension gynaecology consisting of	Qty.
15-921-32-07	⓭	Kirschner, retractor, 78 x 65 mm	2
15-921-31-07		Kirschner, retractor, 85 x 60 mm	2
15-922-40-07		fan, blade, flexible, 140 x 90 mm	1
15-922-32-07		Breisky, blade, 150 x 25 mm	1
15-921-51-07	⓮	Langenbeck, blade, 150 x 50 mm	1
15-921-10-07		blade, flexible, 160 x 50 mm	1
15-921-13-07		blade, flexible, 160 x 75 mm	1
15-921-70-07		Deaver, blade, 150 x 50 mm	1
15-922-33-07		Breisky, blade, 200 x 25 mm	1

* Picture is not showing the complete set

Additional optional sets

marTract® Compact

The marTract® compact is designed for all smaller indications and incisions, whether pediatrics or mamma surgery. The marTract® compact works for both and even more.

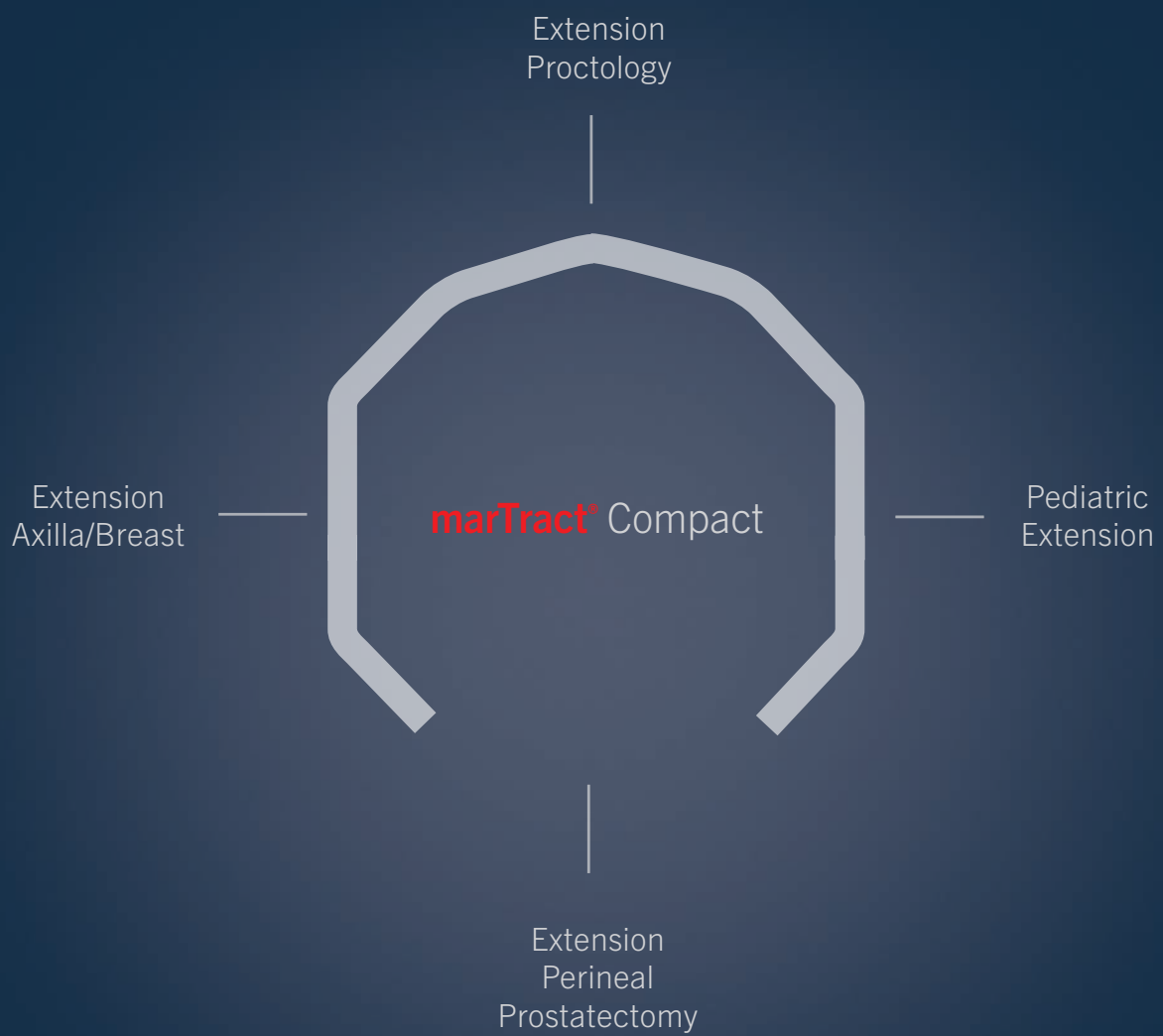

Proctology

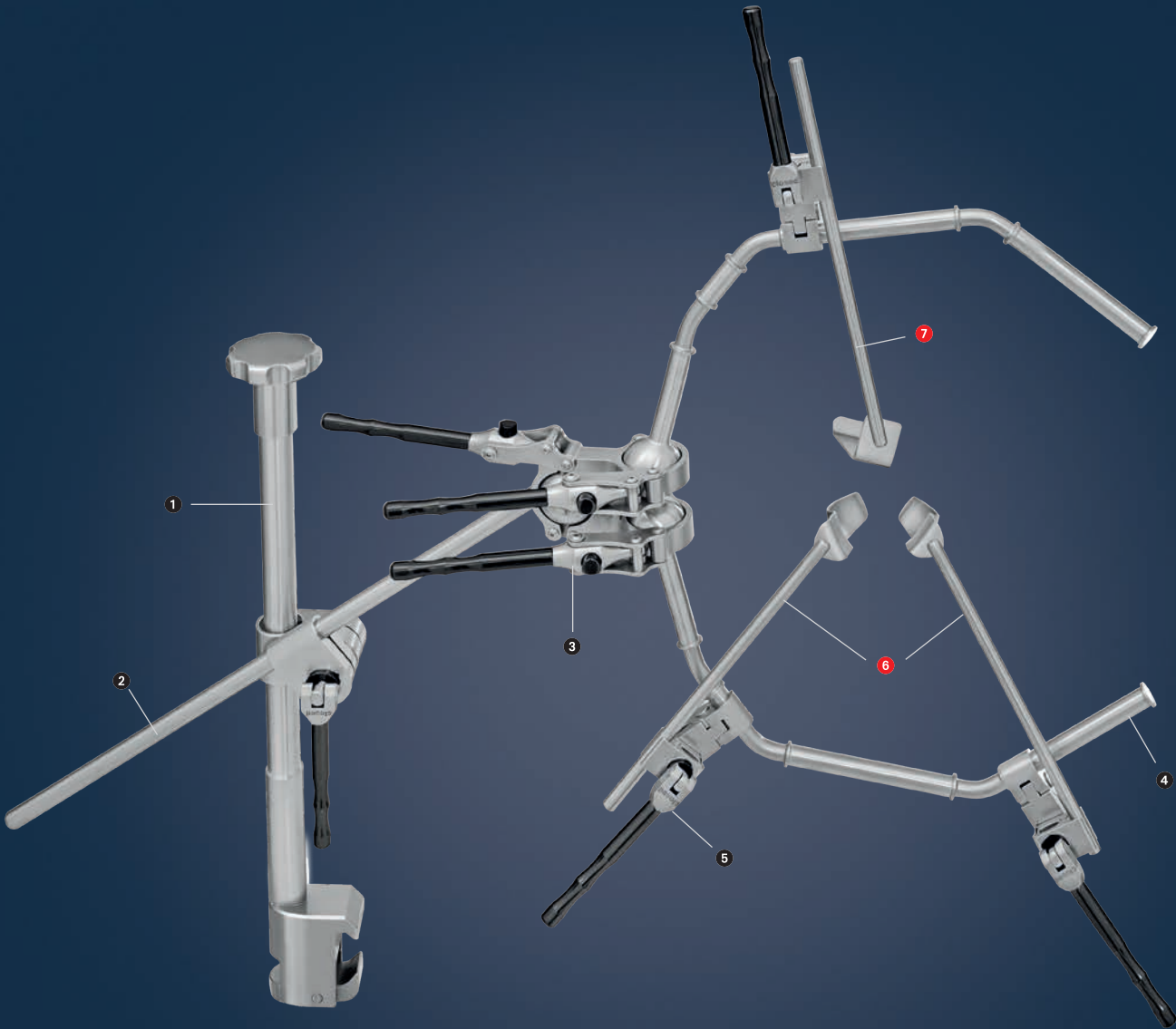

Proctology

The proctology system consists of the compact frame and the extension for proctology.

15-924-40-04		marTract® compact frame consisting of	Qty.
15-920-10-07	①	bracket, operating table	1
15-920-30-07	②	transverse rod for 15-920-34-07	1
15-920-34-07	③	ball mount for holding arms	1
15-920-20-07	④	holding arm, compact system	2
15-920-35-07	⑤	fixing clip for retractor	5

15-924-41-04 *		marTract® extension proctology consisting of	Qty.
15-921-90-07	⑥	Alan-Parks, retractor, 75 x 24 mm	2
15-921-91-07		Alan-Parks, retractor, 95 x 24 mm	2
15-921-42-07	⑦	Langenbeck, retractor, 60 x 20 mm	2
15-921-43-07		Langenbeck, retractor, 80 x 20 mm	2
15-921-44-07		Langenbeck, retractor, 100 x 20 mm	2

* Picture is not showing the complete set

** Not included in the set

Additional optional sets

Pediatric (or Pediatric Urology)

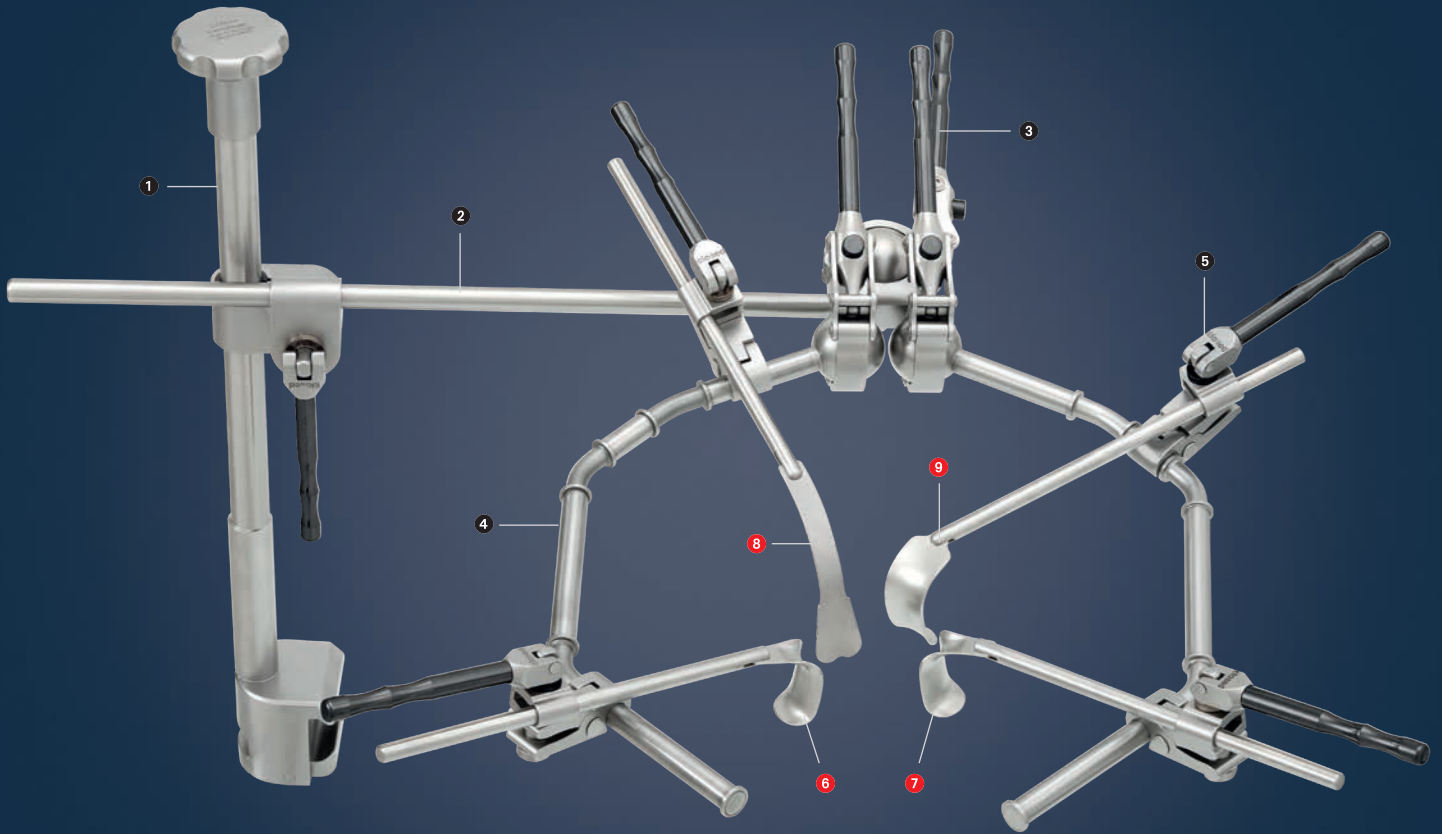

Pediatric System (or Pediatric Urology)

The pediatric system consists of the compact frame and the extension for pediatric surgery.

15-924-40-04		marTract® compact frame consisting of	Qty.
15-920-10-07	❶	bracket, operating table	1
15-920-30-07	❷	transverse rod for 15-920-34-07	1
15-920-34-07	❸	ball mount for holding arms	1
15-920-20-07	❹	holding arm, compact system	2
15-920-35-07	❺	fixing clip for retractor	5

15-924-42-04*		marTract® extension pediatric consisting of	Qty.
15-922-50-07	❻	Richardson, retractor, 25 x 21 mm	2
15-922-51-07	❼	Richardson, retractor, 30 x 29 mm	2
15-922-15-07	❽	Harrington, retractor, flexible, 50 x 25 mm	1
15-921-40-07		Langenbeck, retractor, 35 x 11 mm	2
15-921-41-07		Langenbeck, retractor, 50 x 11mm	2
15-921-20-07		uro, retractor, flexible, 50 x 20 mm	2
15-921-21-07		uro, retractor, flexible, 60 x 20 mm	2
15-922-80-07	❾	Roux, retractor, 22 x 18 mm	2
15-922-81-07		Roux, retractor, 28 x 23 mm	2
15-920-33-07		spacer for radial piston	1

* Picture is not showing the complete set

Additional optional sets

Perineal Prostatectomy

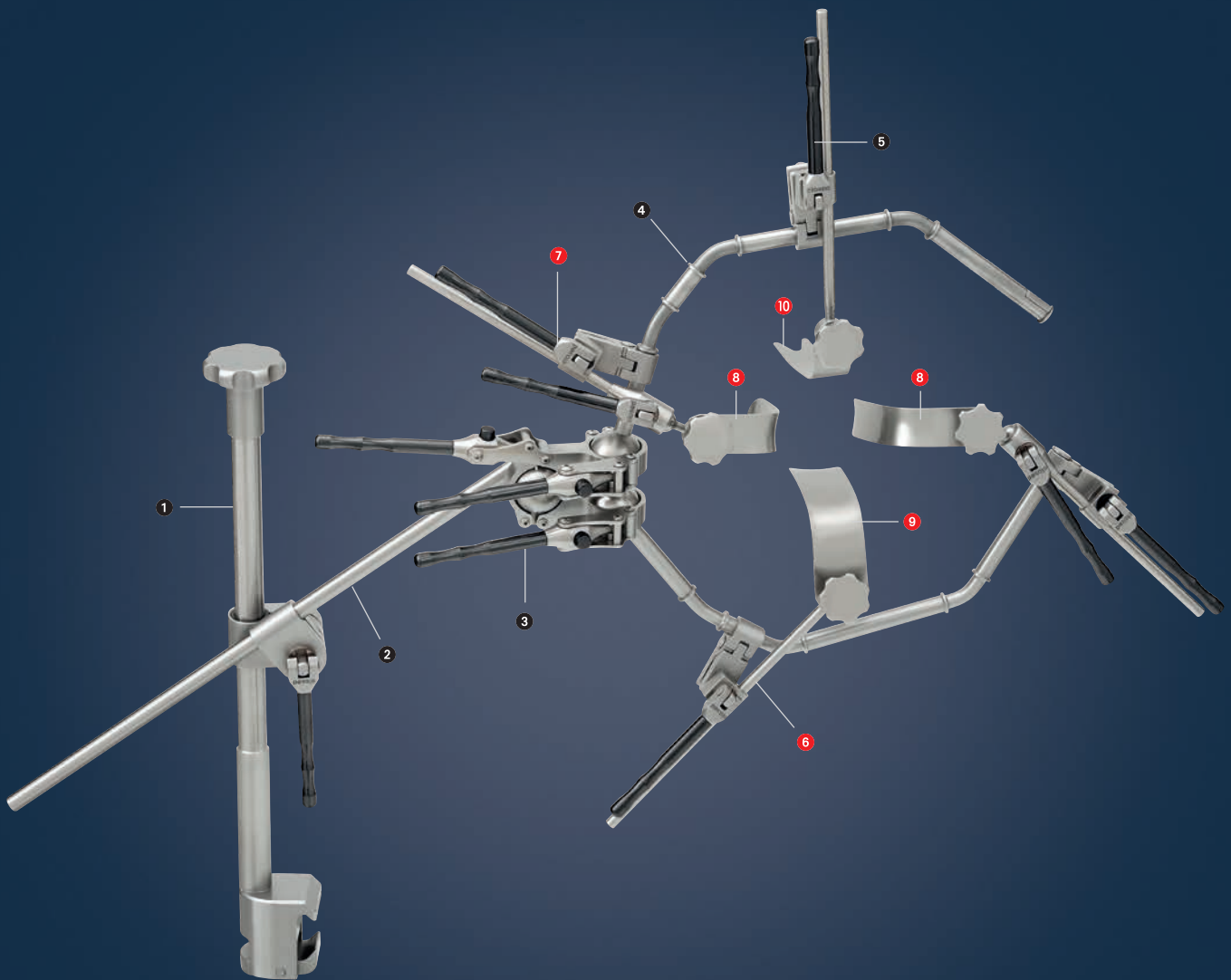

Perineal Prostatectomy

The system for perineal prostatectomy consists of the compact frame and the extension for perineal prostatectomy.

15-924-40-04		marTract® compact frame consisting of	Qty.
15-920-10-07	①	bracket, operating table	1
15-920-30-07	②	transverse rod for 15-920-34-07	1
15-920-34-07	③	ball mount for holding arms	1
15-920-20-07	④	holding arm, compact system	2
15-920-35-07	⑤	fixing clip for retractor	5

15-924-43-04 *		marTract® extension perineal prostatectomy consisting of	Qty.
15-920-40-07	⑥	blade holder, fixed	2
15-920-42-07	⑦	blade holder, movable	2
15-922-30-07	⑧	Breisky, blade, 90 x 25 mm	2
15-922-35-07		Breisky, blade, 90 x 35 mm	1
15-922-36-07	⑨	Breisky, blade, 110 x 35 mm	1
15-921-22-07	⑩	uro, blade, flexible, 100 x 25 mm	1
15-922-71-07		Volkman, retractor, blunt, 22 x 20 mm	1

*Picture is not showing the complete set

Additional optional sets

System for Axilla/Breast

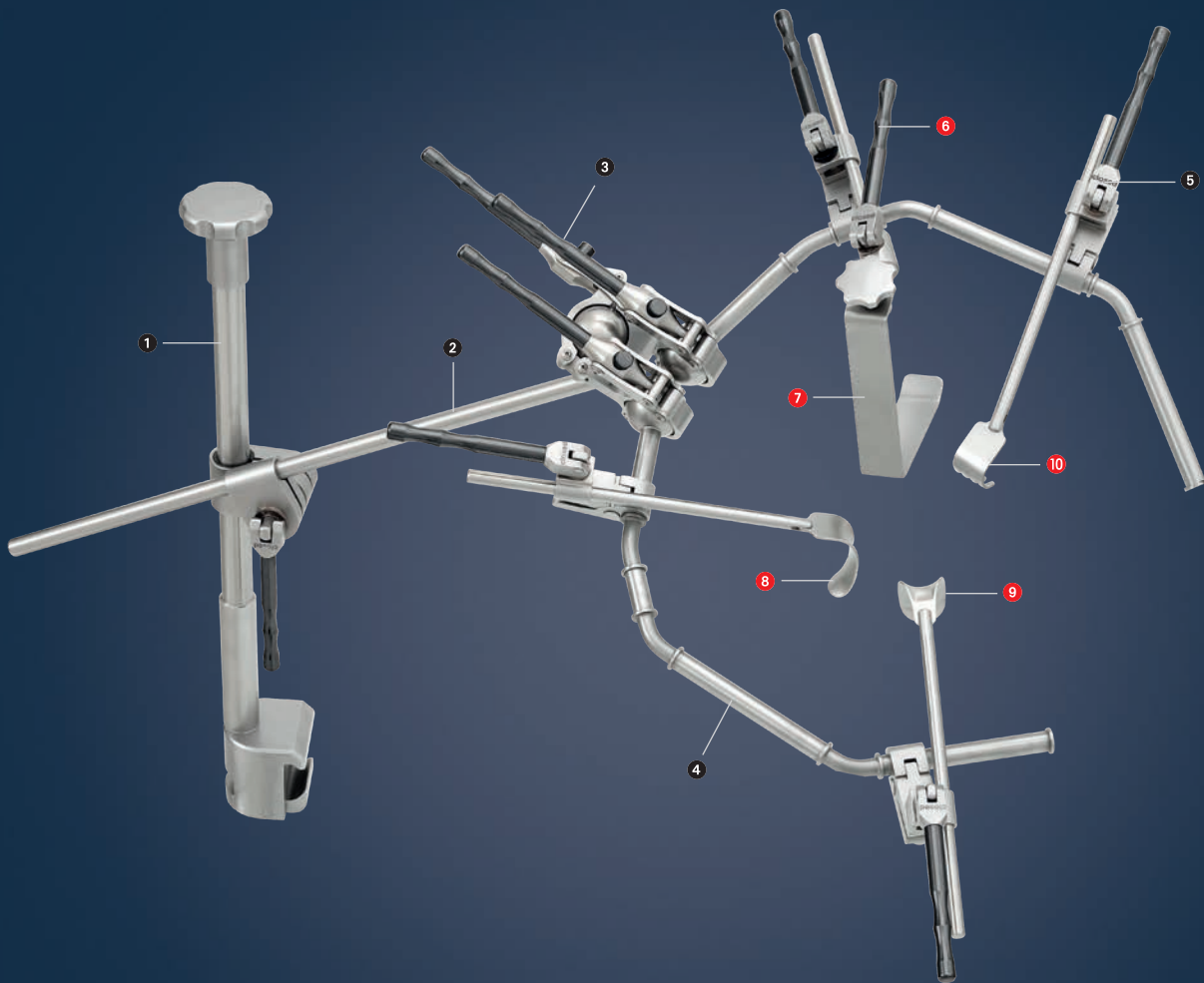

System for Axilla/Breast

The axilla/breast system consists of the compact frame and the extension for axilla/breast surgery.

15-924-40-04		marTract® compact frame consisting of	Qty.
15-920-10-07	❶	bracket, operating table	1
15-920-30-07	❷	transverse rod for 15-920-34-07	1
15-920-34-07	❸	ball mount for holding arms	1
15-920-20-07	❹	holding arm, compact system	2
15-920-35-07	❺	fixing clip for retractor	5

15-924-45-04 *		marTract® extension axilla/breast consisting of	Qty.
15-920-42-07	❻	blade holder, movable	1
15-921-60-07	❼	axilla, blade, 175 x 25 mm	1
15-922-82-07	❽	Roux, retractor, 43 x 23 mm	1
15-922-81-07	❾	Roux, retractor, 28 x 23 mm	1
15-922-70-07	❿	Volkman, retractor, sharp, 22 x 20 mm	1

* Picture is not showing the complete set

Additional optional sets

Reprocessing

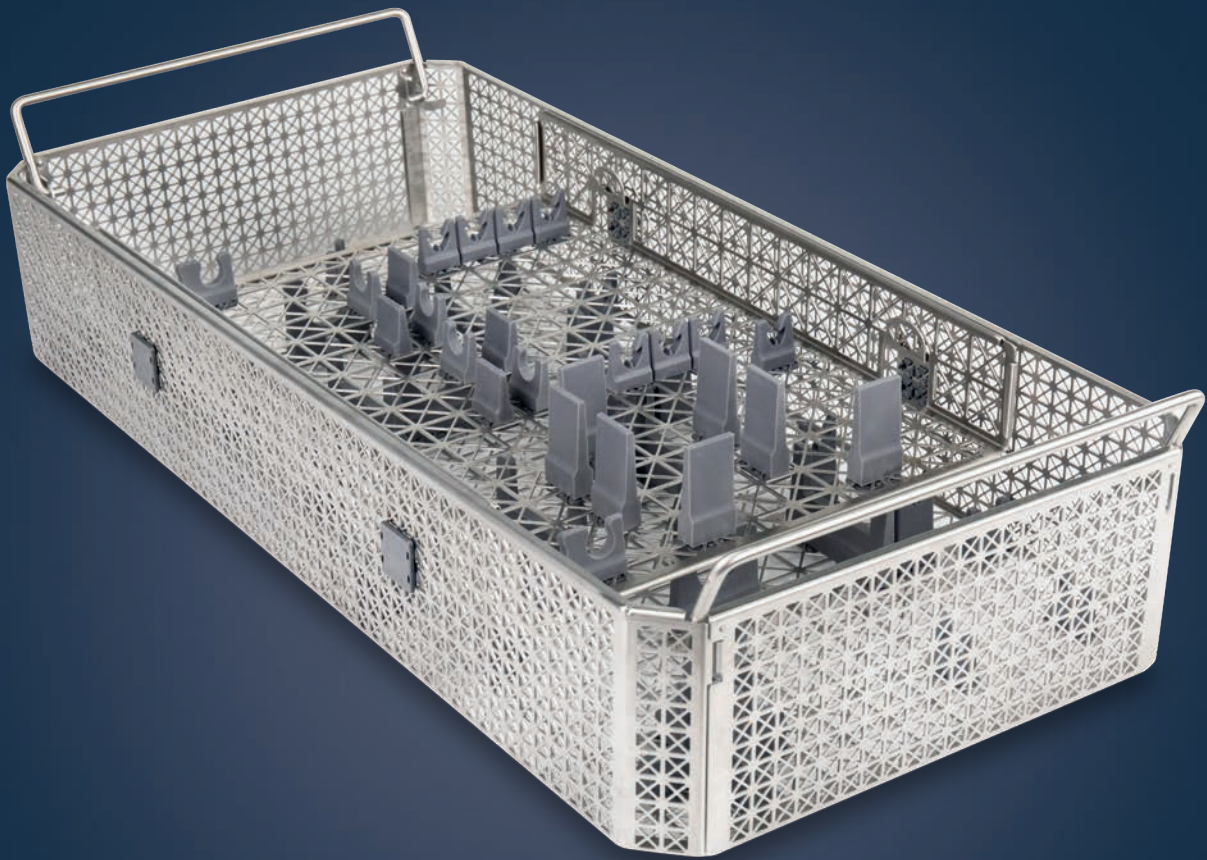

Reprocessing

For each set suggestion a principle storage solution.

Item number	Description
55-801-00-04	storage rack, frame, standard
55-801-10-04	storage rack, abdominal extension
55-801-11-04	storage rack, gynaecology extension
55-801-12-04	storage rack, urology extension
55-801-13-04	storage rack, rectum extension
55-801-14-04	storage rack, kidney extension
55-801-20-04	storage rack, liver epigastrium
55-801-21-04	storage rack, liver abdominal extension
55-801-30-04	storage rack, frame, obesity
55-801-31-04	storage rack, extension, obesity
55-801-32-04	storage rack, extension, gynaecology, obesity
55-801-40-04	storage rack, frame, compact
55-801-41-04	storage rack, proctology extension
55-801-42-04	storage rack, pediatric extension
55-801-43-04	storage rack, perineal prostatectomy extension
55-801-45-04	storage rack, axilla/breast extension



1/3

15-920-10-07
Bracket, operating table



1/3

15-920-11-07
Bracket, operating table,
epigastrium



1/3

15-920-12-07
Bracket, operating table,
MIDCAB



15-920-20-07
Holding arm, compact system



15-920-21-07
Holding arm for kidney add-on



15-920-22-07
Holding arm, standard system



15-920-23-07
Holding arm, obesity system

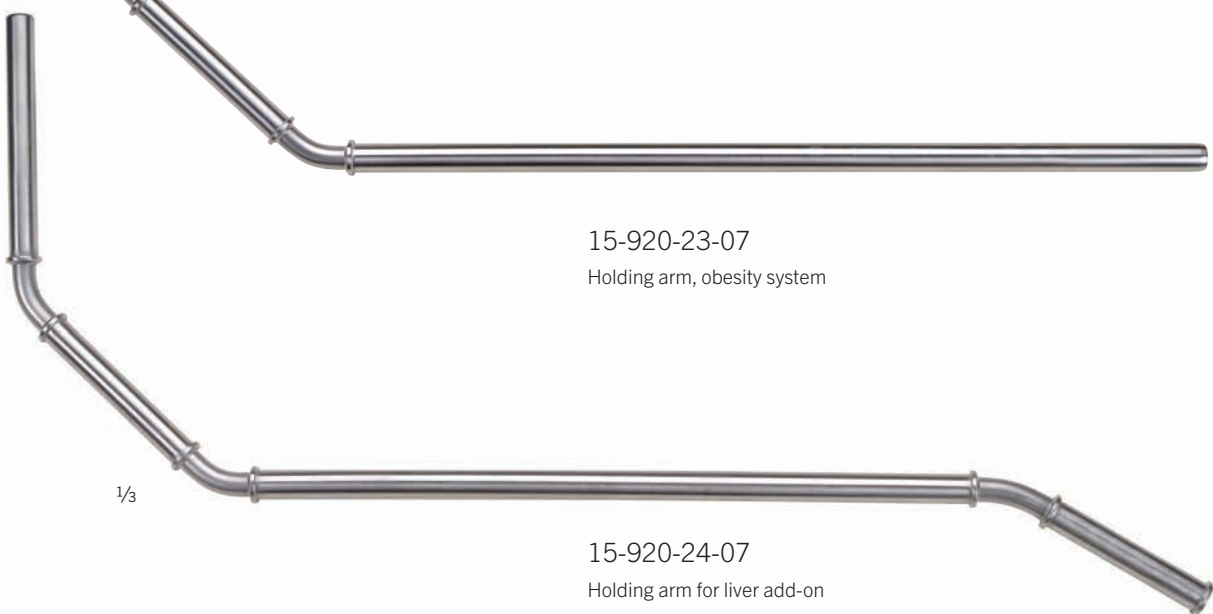

15-920-24-07
Holding arm for liver add-on



15-920-25-07
Holding arm with angle, MIDCAB



15-920-30-07
Transverse rod for 15-920-34-07



15-920-31-07
Extension for rectum add-on



15-920-33-07
Spacer for radial piston
for raising working height
Attached under sterile drape on OT-table



1/3

15-920-32-07
Connector for obesity system



1/3

15-920-34-07
Ball mount for holding arms



1/3

15-920-35-07
Fixing clip for retractor



1/3

15-920-40-07
Blade holder, fixed



1/3

15-920-42-07
Blade holder, movable



1/3

15-920-43-07
Blade holder for epigastrium add-on
for 15-920-51-07



1/3

15-920-44-07
Blade holder, with stop, 20 cm



1/3

15-920-45-07
Blade holder, with stop, 40 cm



1/3

15-920-47-07
Adapter, tissue stabilizer

1/3



15-920-46-07
Optics bracket, flexible
(suitable adapter required)

Item number	Adapter for optics bracket, flexible Ø
15-920-53-07	10 mm
15-920-54-07	5 mm
15-920-55-07	4 mm
15-920-56-07	3 mm

1/3



1/3



15-920-51-07
Pulling device for epigastrium

15-920-52-07
Pulling device for MIDCAB

1/3

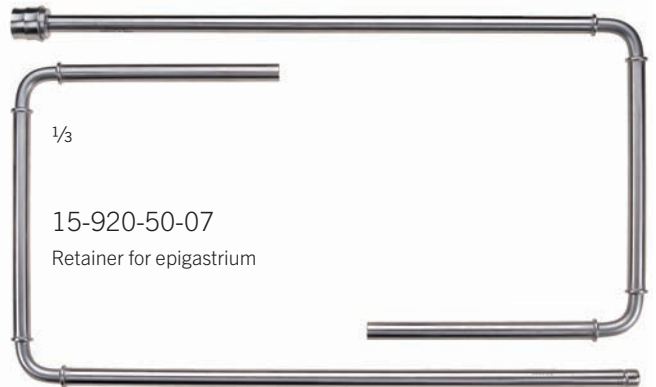

15-920-50-07
Retainer for epigastrium



1/3

15-920-90-07

Fixation arm for
aparoscopic Liver hooklet

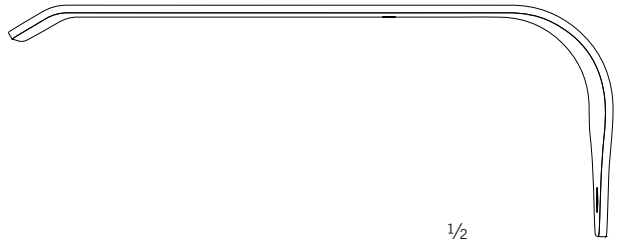

1/2

15-921-01-07

150 x 100 mm



1/2

15-921-02-07

200 x 100 mm



1/2

15-921-03-07

250 x 100 mm



1/3

15-921-01-07 -

15-921-03-07

Intestine blade, wide

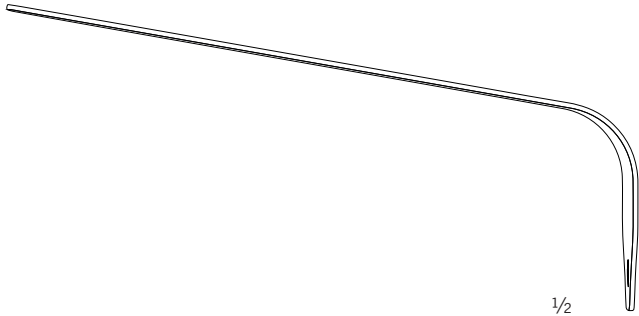

1/2

15-921-10-07
160 x 50 mm

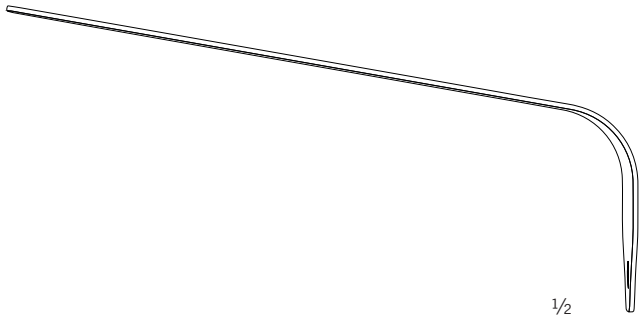

1/2

15-921-13-07
160 x 75 mm



1/3

15-921-10-07 -
15-921-13-07
Blade, flexible

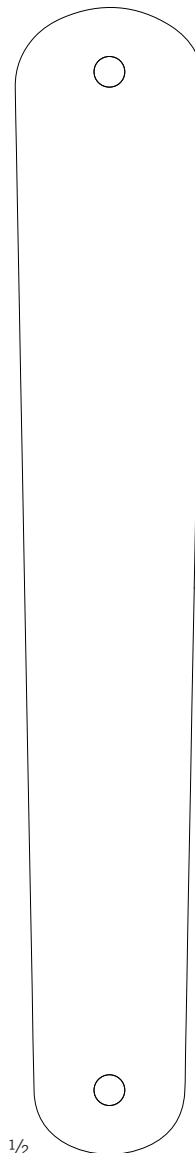

1/2

15-921-12-07
300 x 50 mm
Spatula, flexible



1/3

15-921-20-07 -
15-921-21-07
Uro, Retractor, flexible

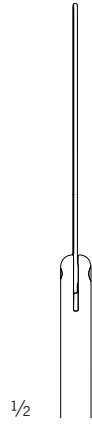

15-921-20-07
50 x 20 mm

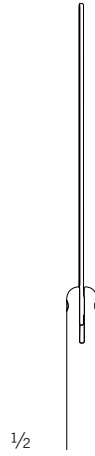

15-921-21-07
60 x 20 mm



1/3

15-921-22-07
100 x 25 mm
Uro, blade, flexible

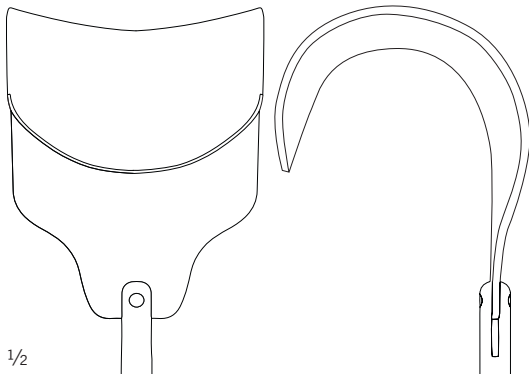

1/2

15-921-30-07
50 x 65 mm

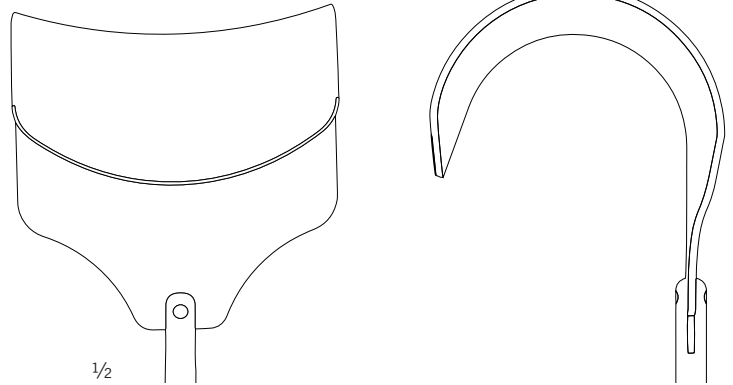

1/2

15-921-31-07
60 x 85 mm

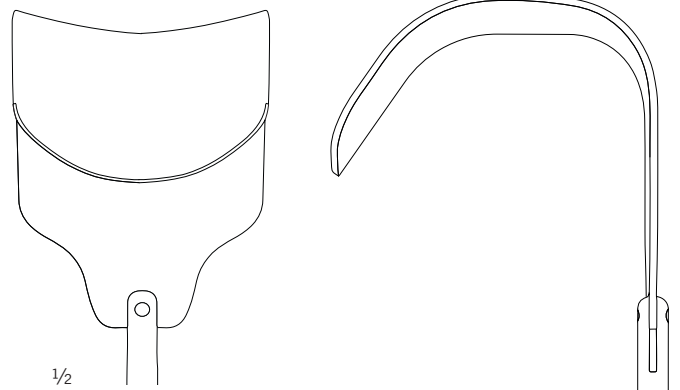

1/2

15-921-32-07
78 x 65 mm



1/3

Kirschner
15-921-30-07 -
15-921-33-07
Retractor

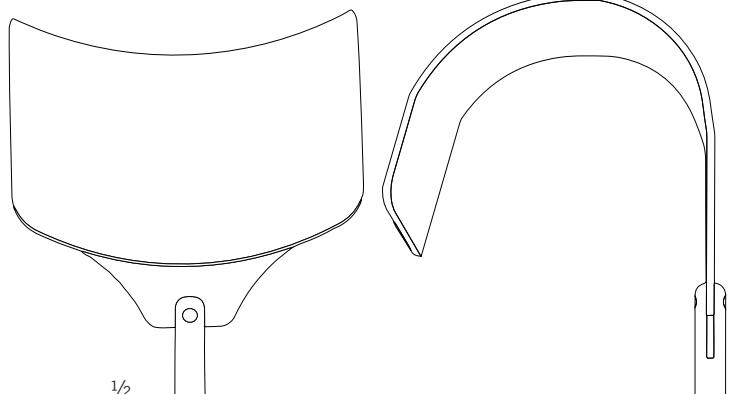

1/2

15-921-33-07
80 x 90 mm

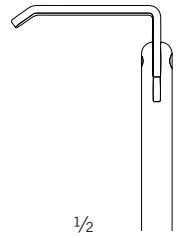

15-921-40-07
35 x 11 mm

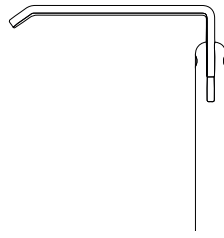

15-921-41-07
50 x 11 mm

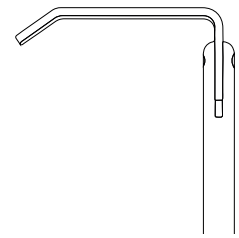

15-921-42-07
60 x 20 mm

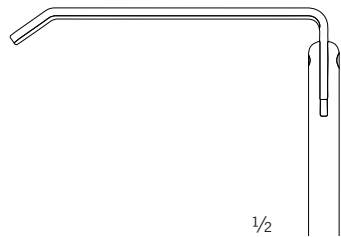

15-921-43-07
80 x 20 mm



15-921-44-07
100 x 20 mm



Langenbeck
15-921-40-07 -
15-921-44-07
Retractor



1/3

Langenbeck
15-921-50-07 -
15-921-52-07
Blade

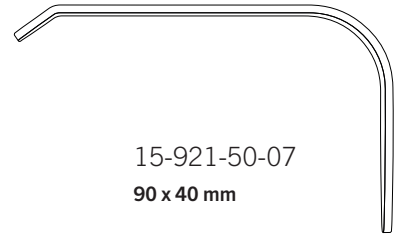

15-921-50-07
90 x 40 mm

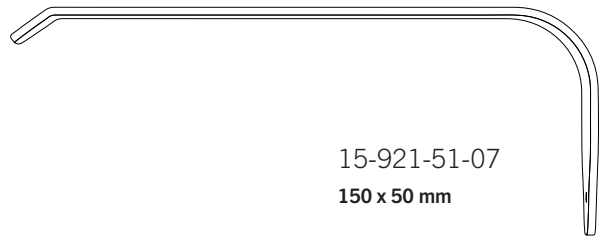

15-921-51-07
150 x 50 mm

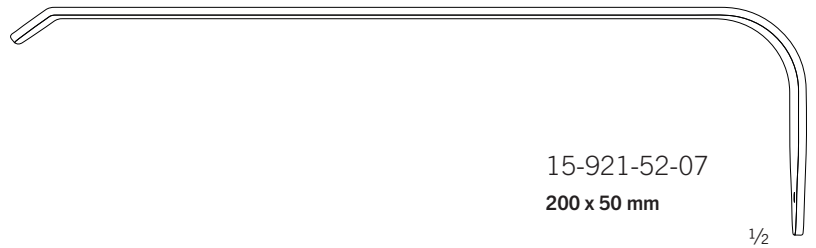

15-921-52-07
200 x 50 mm

1/2



1/3

15-921-60-07
175 x 25 mm
Axila, blade



1/3

Deaver
15-921-70-07
15-921-72-07
Blade



Deaver
15-921-80-07
200 x 70 mm
Retractor

1/3

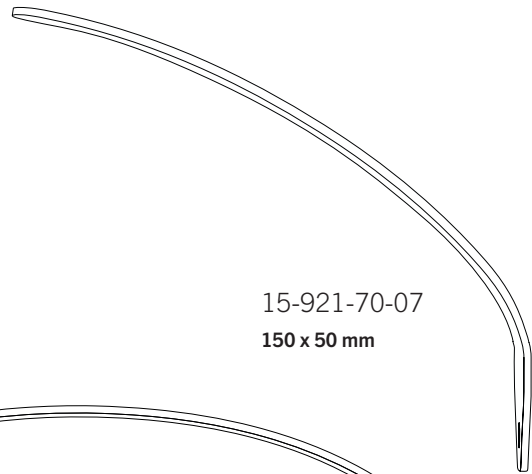

15-921-70-07
150 x 50 mm

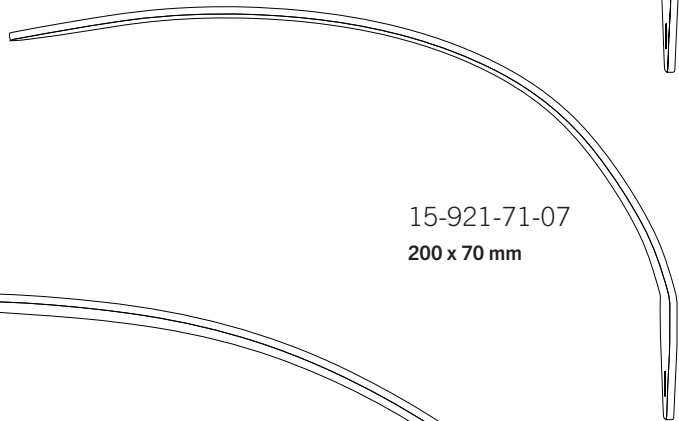

15-921-71-07
200 x 70 mm



15-921-72-07
220 x 100 mm

1/2



1/3

Alan-Parks
15-921-90-07 -
15-921-91-07
Retractor

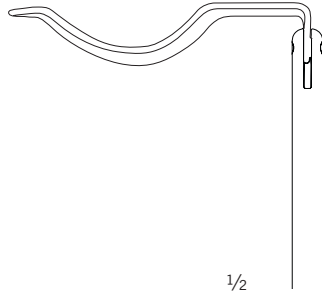

1/2

15-921-90-07
75 x 24 mm



15-921-91-07
95 x 24 mm



1/3

15-922-01-07
150 x 80 mm
Bladder, blade, flexible



1/3

Harrington
15-922-10-07
15-922-11-07
Blade, flexible

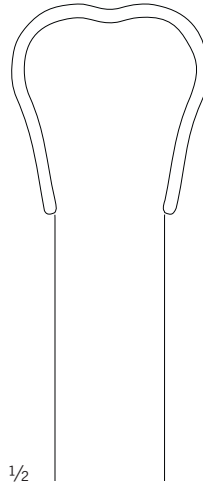

1/2

15-922-10-07
175 x 50 mm

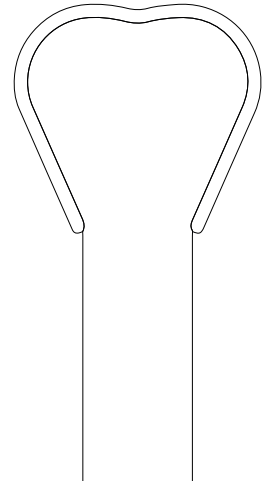

15-922-11-07
175 x 65 mm



1/3

Harrington
15-922-15-07
50 x 25 mm
Retractor



1/3

15-922-20-07
125 x 50 mm
Retractor, slotted

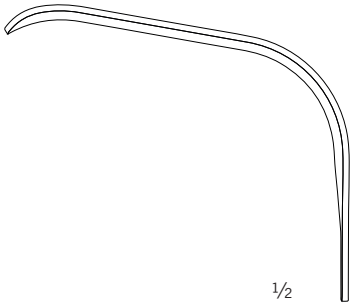

1/2

15-922-30-07
90 x 25 mm

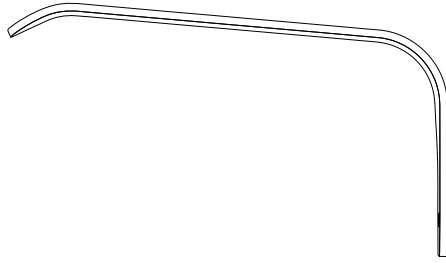

15-922-31-07
110 x 25 mm

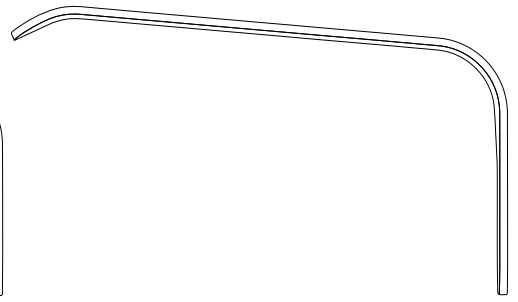

15-922-32-07
150 x 25 mm



1/2

15-922-33-07
200 x 25 mm

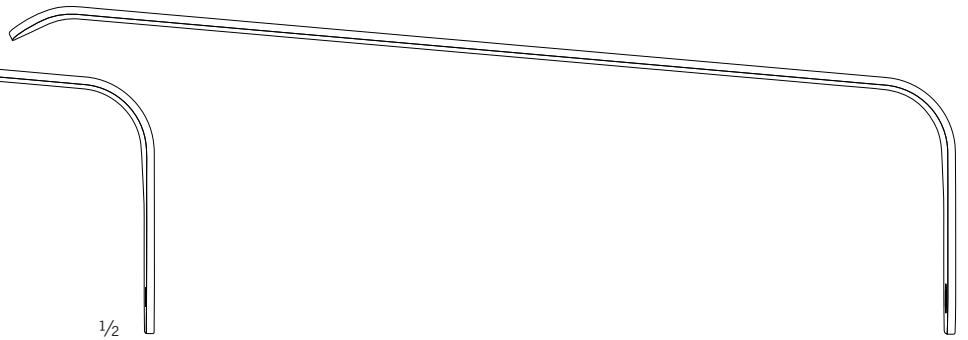

15-922-34-07
250 x 25 mm



1/3

Breisky
15-922-30-07
15-922-36-07
Blade

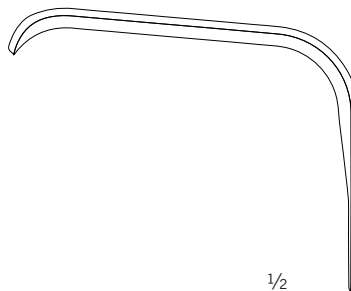

1/2

15-922-35-07
90 x 35 mm

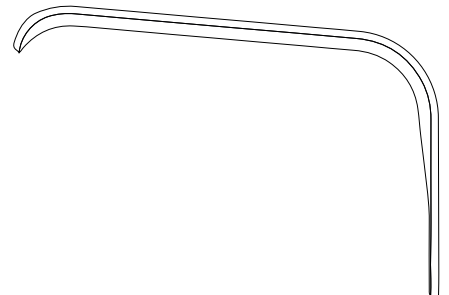

15-922-36-07
110 x 35 mm

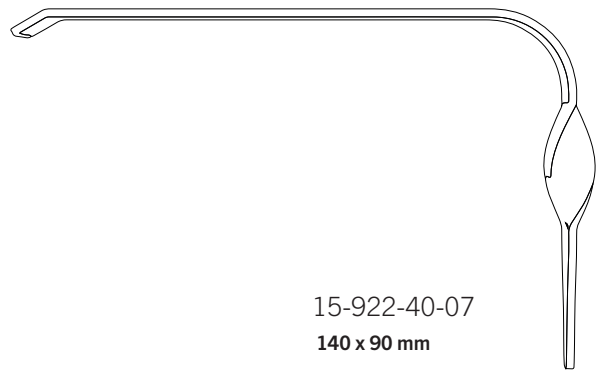
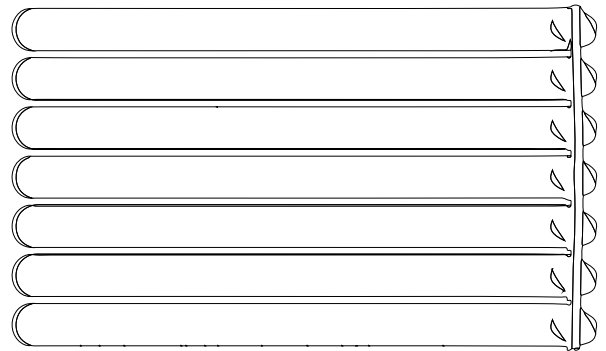

15-922-40-07
140 x 90 mm



1/3

15-922-40-07
15-922-41-07
Fan, blade, flexible

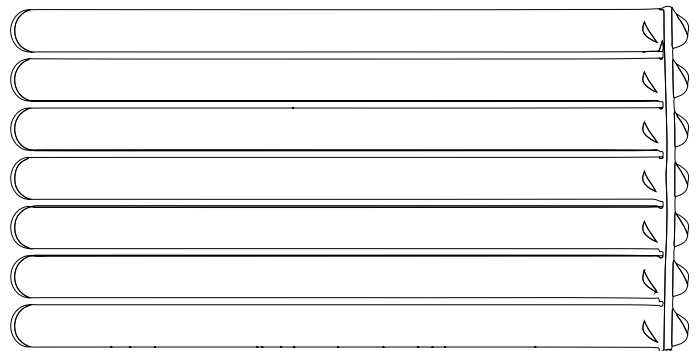

15-922-41-07
165 x 90 mm

1/2



Richardson
15-922-50-07
15-922-51-07
Retractor

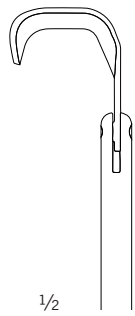

15-922-50-07
25 x 21 mm

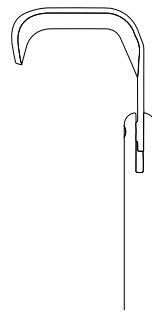

15-922-51-07
30 x 29 mm

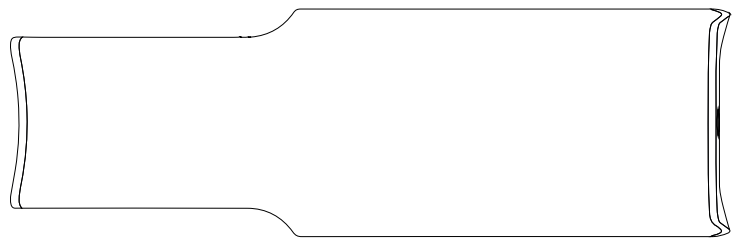

15-922-60-07
174 x 60 mm

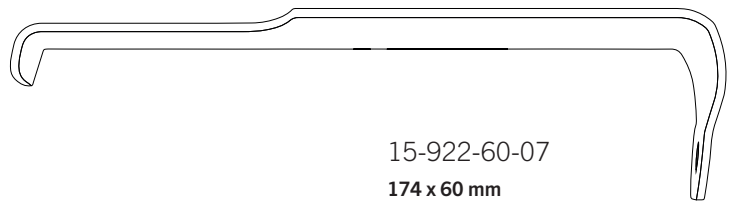

15-922-61-07
270 x 60 mm

1/2



1/3

St. Marks
15-922-60-07
15-922-61-07
Blade, pelvis

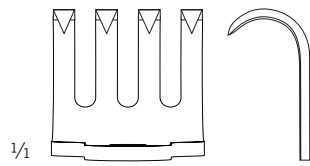

15-922-70-07
22 x 20 mm
sharp

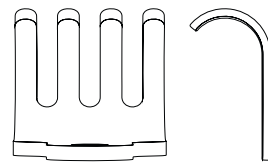

15-922-71-07
22 x 20 mm
blunt

Volkman
15-922-70-07
15-922-71-07
Retractor

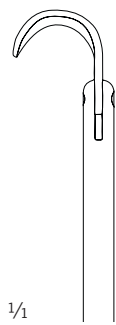

15-922-80-07
22 x 18 mm

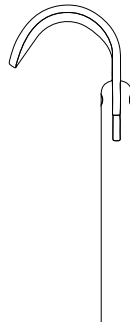

15-922-81-07
28 x 23 mm

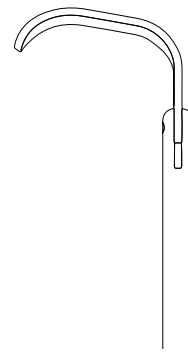

15-922-82-07
43 x 23 mm

Roux
15-922-80-07
15-922-82-07
Retractor

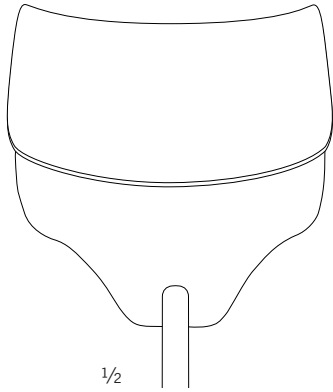

15-922-90-07
60 x 85 mm

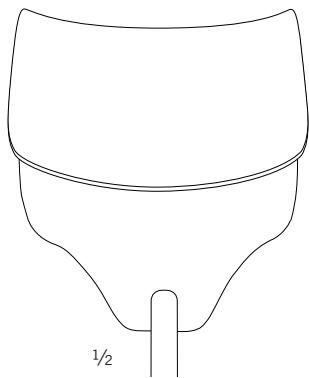
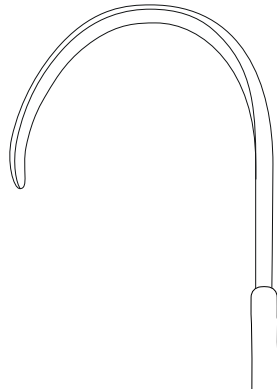

15-922-91-07
65 x 78 mm

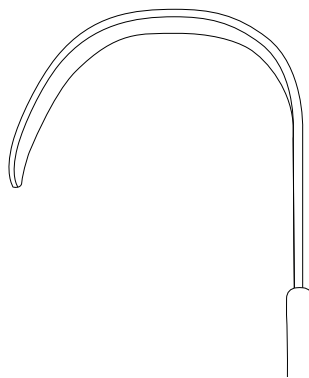

15-922-90-07
15-922-91-07
Epigastrium,
in connection with 15-920-51-07



15-922-95-07
laparoscopic liver hooklet / size M

15-922-96-07
laparoscopic liver hooklet / size L



1/3

15-923-21-07 -
15-923-23-07

Retractor, MIDCAB, 2-pronged

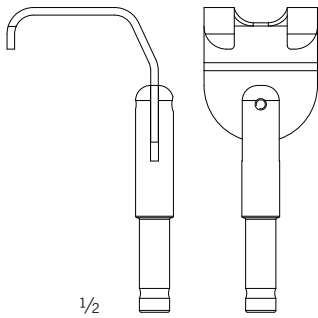

1/2

15-923-21-07
40 x 30 mm

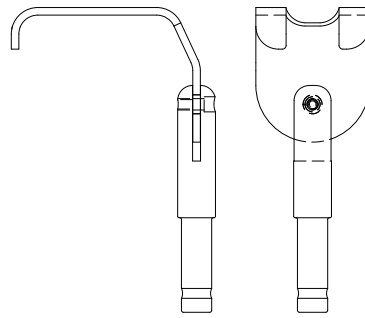

15-923-22-07
50 x 30 mm

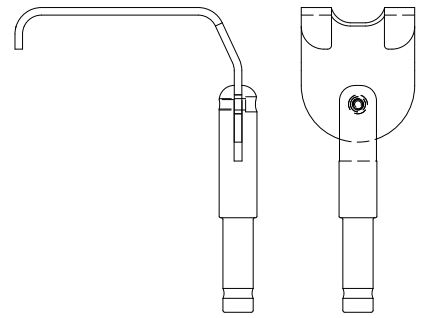

15-923-23-07
60 x 30 mm



1/3

15-923-24-07 -
15-923-25-07

Wound Retractor, MIDCAB

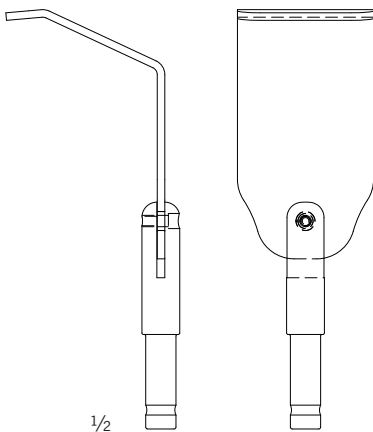

1/2

15-923-24-07
42 x 36 mm

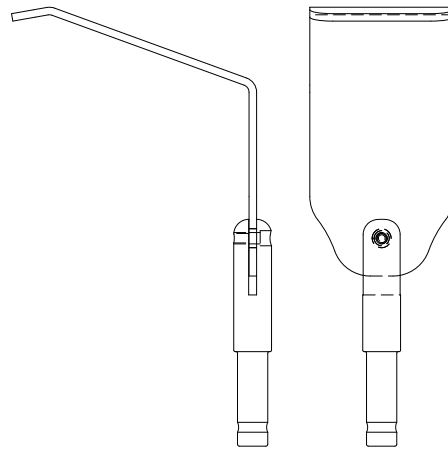

15-923-25-07
65 x 38 mm



1/3

15-923-26-07 -
15-923-27-07

Wound Retractor, MIDCAB

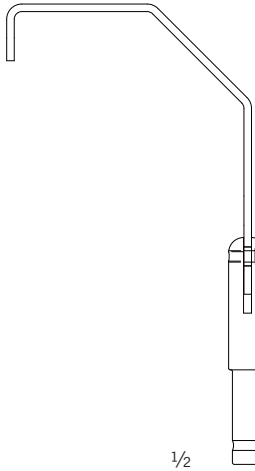

1/2

15-923-26-07
65 x 50 mm

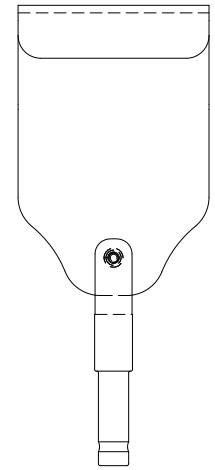
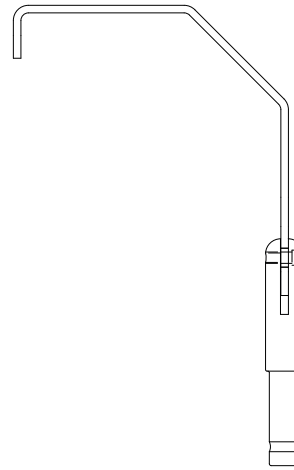
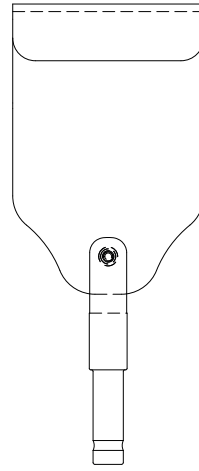

15-923-27-07
70 x 50 mm



1/3

15-923-28-07 -
15-923-29-07

Wound Retractor, MIDCAB

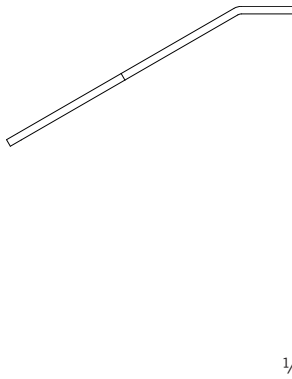

1/2

15-923-28-07
92 x 51 mm

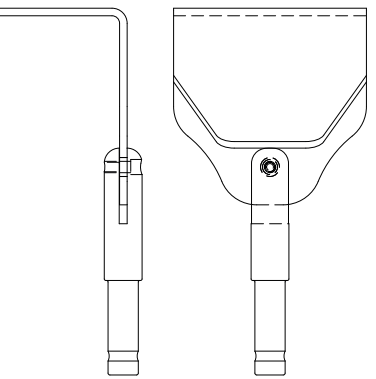
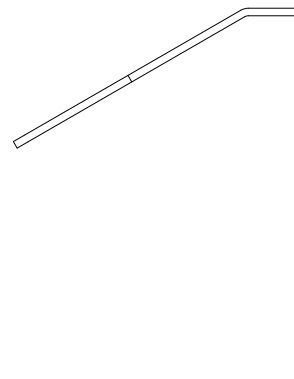
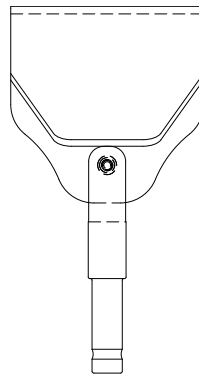

15-923-29-07
103 x 51 mm



1/3

15-923-30-07 -
15-923-31-07

Wound Retractor, MIDCAB

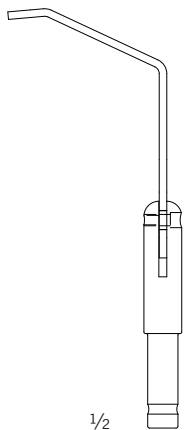

1/2

15-923-30-07
42 x 57 mm

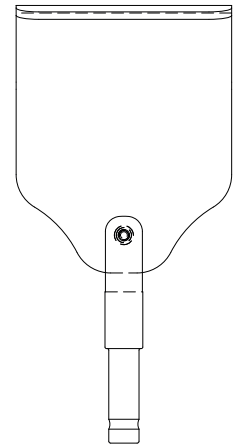
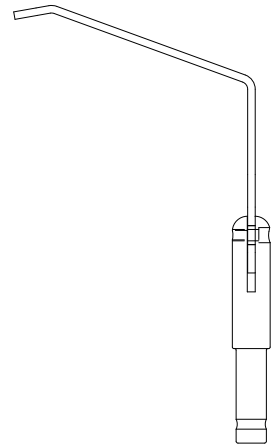
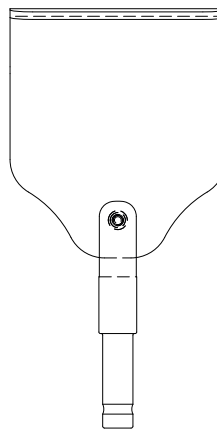

15-923-31-07
65 x 57 mm

15

15-920-10-07..... 11, 13, 15, 17, 19, 23,
..... 29, 31, 35, 37, 39, 41, 44
15-920-11-07..... 21, 44
15-920-12-07..... 25, 44
15-920-20-07..... 35, 37, 39, 41, 45
15-920-21-07..... 19, 45
15-920-22-07..... 11, 13, 15, 17, 19, 45
15-920-23-07..... 29, 31, 45
15-920-24-07..... 21, 45
15-920-25-07..... 25, 46
15-920-30-07..... 11, 13, 15, 17, 19,
..... 29, 31, 35, 37, 39, 41, 46
15-920-31-07..... 17, 46
15-920-32-07..... 29, 31, 47
15-920-33-07..... 21, 23, 29, 31, 37, 46
15-920-34-07..... 11, 13, 15, 17, 19,
..... 29, 31, 35, 37, 39, 41, 47
15-920-35-07..... 11, 13, 15, 17, 19, 21,
..... 25, 29, 31, 35, 37, 39, 41, 47
15-920-40-07..... 11, 13, 15, 17, 19,
..... 21, 39, 47
15-920-42-07..... 11, 13, 15, 17, 19,
..... 21, 29, 31, 39, 41, 47
15-920-43-07..... 21, 47
15-920-44-07..... 29, 31, 47
15-920-45-07..... 21, 29, 47
15-920-46-07..... 25, 48
15-920-47-07..... 25, 47
15-920-50-07..... 21, 48
15-920-51-07..... 21, 48
15-920-52-07..... 25, 48
15-920-53-07..... 48
15-920-54-07..... 48
15-920-55-07..... 48
15-920-56-07..... 48
15-920-90-07..... 23, 48
15-921-01-07..... 29, 49
15-921-02-07..... 29, 31, 49
15-921-03-07..... 29, 31, 49
15-921-10-07..... 11, 13, 15, 17, 19,
..... 21, 31, 50
15-921-12-07..... 17, 50
15-921-13-07..... 11, 13, 15, 17, 19,
..... 31, 50
15-921-20-07..... 37, 51
15-921-21-07..... 37, 51
15-921-22-07..... 39, 51
15-921-30-07..... 19, 52
15-921-31-07..... 11, 13, 15, 17,
..... 21, 31, 52
15-921-32-07..... 11, 13, 15, 17,
..... 21, 31, 52
15-921-33-07..... 29, 31, 52
15-921-40-07..... 37, 53
15-921-41-07..... 37, 53
15-921-42-07..... 35, 53

15-921-43-07..... 35, 53
15-921-44-07..... 35, 53
15-921-50-07..... 19, 54
15-921-51-07..... 11, 13, 15, 17, 19,
..... 21, 31, 54
15-921-52-07..... 21, 29, 54
15-921-60-07..... 41, 54
15-921-70-07..... 11, 13, 15, 17,
..... 31, 55
15-921-71-07..... 29, 31, 55
15-921-72-07..... 29, 31, 55
15-921-80-07..... 31, 55
15-921-90-07..... 35, 56
15-921-91-07..... 35, 56
15-922-01-07..... 15, 56
15-922-10-07..... 19, 21, 57
15-922-11-07..... 19, 21, 57
15-922-15-07..... 37, 57
15-922-20-07..... 19, 57
15-922-30-07..... 39, 58
15-922-31-07..... 19, 58
15-922-32-07..... 11, 13, 15, 17,
..... 19, 21, 31, 58
15-922-33-07..... 13, 17, 19, 31, 58
15-922-34-07..... 17, 58
15-922-35-07..... 39, 58
15-922-36-07..... 39, 58
15-922-40-07..... 11, 13, 15, 17,
..... 21, 31, 59
15-922-41-07..... 29, 31, 59
15-922-50-07..... 37, 60
15-922-51-07..... 37, 60
15-922-60-07..... 17, 61
15-922-61-07..... 17, 61
15-922-70-07..... 41, 62
15-922-71-07..... 39, 62
15-922-80-07..... 37, 62
15-922-81-07..... 37, 41, 62
15-922-82-07..... 41, 62
15-922-90-07..... 21, 63
15-922-91-07..... 21, 63
15-922-95-07..... 23, 63
15-922-96-07..... 23, 63
15-923-21-07..... 25, 64
15-923-22-07..... 25, 64
15-923-23-07..... 25, 64
15-923-24-07..... 25, 64
15-923-25-07..... 25, 64
15-923-26-07..... 25, 65
15-923-27-07..... 25, 65
15-923-28-07..... 25, 65
15-923-29-07..... 25, 65
15-923-30-07..... 25, 65
15-923-31-07..... 25, 65
15-924-00-04..... 11, 13, 15, 17, 19
15-924-10-04..... 11, 17
15-924-11-04..... 13, 31

15-924-12-04..... 15
15-924-13-04..... 17
15-924-14-04..... 19
15-924-20-0..... 21
15-924-21-04..... 21
15-924-30-04..... 29, 31
15-924-31-04..... 29
15-924-32-04..... 31
15-924-40-04..... 35, 37, 39, 41
15-924-41-04..... 35
15-924-42-04..... 37
15-924-43-04..... 39
15-924-45-04..... 41
15-924-46-04..... 25

15

55-801-00-04..... 43
55-801-10-04..... 43
55-801-11-04..... 43
55-801-12-04..... 43
55-801-13-04..... 43
55-801-14-04..... 43
55-801-20-04..... 43
55-801-21-04..... 43
55-801-30-04..... 43
55-801-31-04..... 43
55-801-32-04..... 43
55-801-40-04..... 43
55-801-41-04..... 43
55-801-42-04..... 43
55-801-43-04..... 43
55-801-45-04..... 43

KLS Martin Group

KLS Martin Australia Pty Ltd.

Sydney · Australia
Tel. +61 2 9439 5316
australia@klsmartin.com

KLS Martin Italia S.r.l.

Milan · Italy
Tel. +39 039 605 67 31
info@klsmartin.com

KLS Martin Nederland B.V.

Huizen · Netherlands
Tel. +31 35 523 45 38
infonl@klsmartin.com

KLS Martin UK Ltd.

Reading · United Kingdom
Tel. +44 118 467 1500
info.uk@klsmartin.com

KLS Martin do Brasil Ltda.

São Paulo · Brazil
Tel. +55 11 3554 2299
brazil@klsmartin.com

KLS Martin Japan K.K.

Tokyo · Japan
Tel. +81 3 3814 1431
info@klsmartin.com

KLS Martin SE & Co. KG

Moscow · Russia
Tel. +7 499 792 76 19
russia@klsmartin.com

KLS Martin LP

Jacksonville · Florida, USA
Tel. +1 904 641 77 46
usa@klsmartin.com

KLS Martin Medical (Shanghai) International Trading Co., Ltd

Shanghai · China
Tel. +86 21 5820 6251
info@klsmartin.com

KLS Martin SE Asia Sdn. Bhd.

Penang · Malaysia
Tel. +604 261 7060
malaysia@klsmartin.com

KLS Martin Taiwan Ltd.

Taipei · Taiwan
Tel. +886 2 2325 3169
taiwan@klsmartin.com

KLS Martin SE Asia Sdn. Bhd.

Hanoi · Vietnam
Tel. +49 7461 706-0
info@klsmartin.com

KLS Martin India Pvt Ltd.

Chennai · India
Tel. +91 44 66 442 300
india@klsmartin.com

KLS Martin de México, S.A. de C.V.

Mexico City · Mexico
Tel. +52 55 7572 0944
mexico@klsmartin.com

KLS Martin SE & Co. KG

Dubai · United Arab Emirates
Tel. +971 4 454 16 55
middleeast@klsmartin.com

KLS Martin SE & Co. KG

A company of the KLS Martin Group

KLS Martin Platz 1 · 78532 Tuttlingen · Germany
PO Box 60 · 78501 Tuttlingen · Germany
Tel. +49 7461 706-0 · Fax +49 7461 706-193
info@klsmartin.com · www.klsmartin.com